



MS 50-165/T black-EN54

- Distinctive design
- Excellent sound
- IP 65



EN 54-24:2008
Ref. Nr.: 011-13
ID-Code: SAA-LS11
1438-CPR-0998

ic audio GmbH, Boehringerstraße 14a,
D-68307 Mannheim, Germany

CE-Symbol gemäß Richtlinie 93/68EWG

The compact monitor speaker impresses with its sophisticated design and its powerful sound. Perfectly suitable for installations where high sound quality is needed.

The 50W powered speaker is equipped with a high-quality 2-way system and a 100V transformer with 3 power adjustments. Low-impedance operation with 8 ohms is possible. The impact-resistant, UV-resistant ABS plastic housing in RAL 9005 assures enduring stability. For additional reliability, a wetness impregnation of the speaker is provided.

The speaker is also secured with protection class IP 65 against the risks of environmental influences. A comfortable connection of the speaker is made possible by a stable screw terminal with contact protection. Quick and easy mounting with wall mounting bracket.

Product	MS 50-165/T black-EN54
Artikel Nr.	20122648

Acoustics

Power	50/25/12,5/6,25 (8ohm) W
Impedance (100V)	200/400/800/1600 ohm
Speaker ø	165 mm
Frequency Range	52 - 24.000 Hz
Frequency Response	48 - 25.000 Hz
SPL 1W/1m, peak	88,8 dB
SPL 1W/4m, peak	76,8 dB
SPL Pmax/4m, peak	93,7 dB
SPL IEC268-5, 1W/1m	84,8 dB
SPL IEC268-5, Pmax/1m	101,8 dB
Sensitivity EN54-24, 1W/1m	84,8 dB
Sensitivity EN54-24, 1W/4m	72,8 dB
Dispersion -6dB, 500Hz	360° (h) 360° (v)
Dispersion -6dB, 1KHz	200° (h) 155° (v)
Dispersion -6dB, 2KHz	110° (h) 120° (v)
Dispersion -6dB, 4KHz	80° (h) 25° (v)

Connections and Housing

Connector	6-pin screw terminal
Terminal Diameter	2,5 mm
Maximum Cable Passage	4,9 mm ²
Temperature Range	-25 / +70 °C
Type A/B	B
Dimensions	325X202X192 mm
Weight (net)	4,0 kg
Housing	ABS
Horizontal Adjustment	-50°...50° (10° steps)
Vertical Adjustment	-30°...30° (10° steps)
Colour	RAL 9005
Mounting	Swivel bracket
IP Rating	IP65

Certification

Ref. Nr.	011-13
ID-Code	SAA-LS11
Certificate Number	1438-CPR-0998

Product Attributes



Technical Drawing



MS 50-165/T-EN54

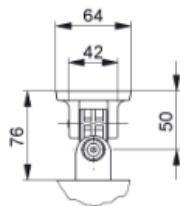
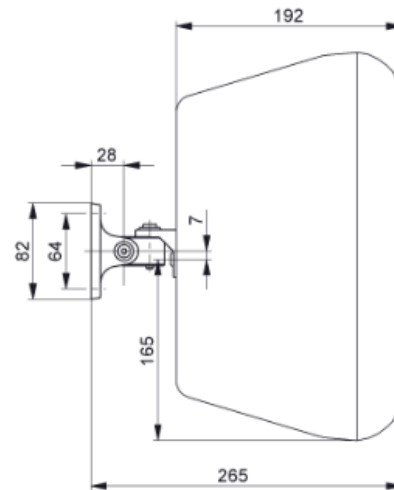
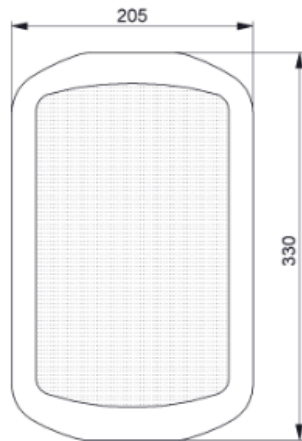

Horizontal plane
in steps of 10°

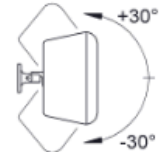

Vertical plane
in steps of 10°

all dimensions are in mm

Frequency Response Diagram

Sensitivity

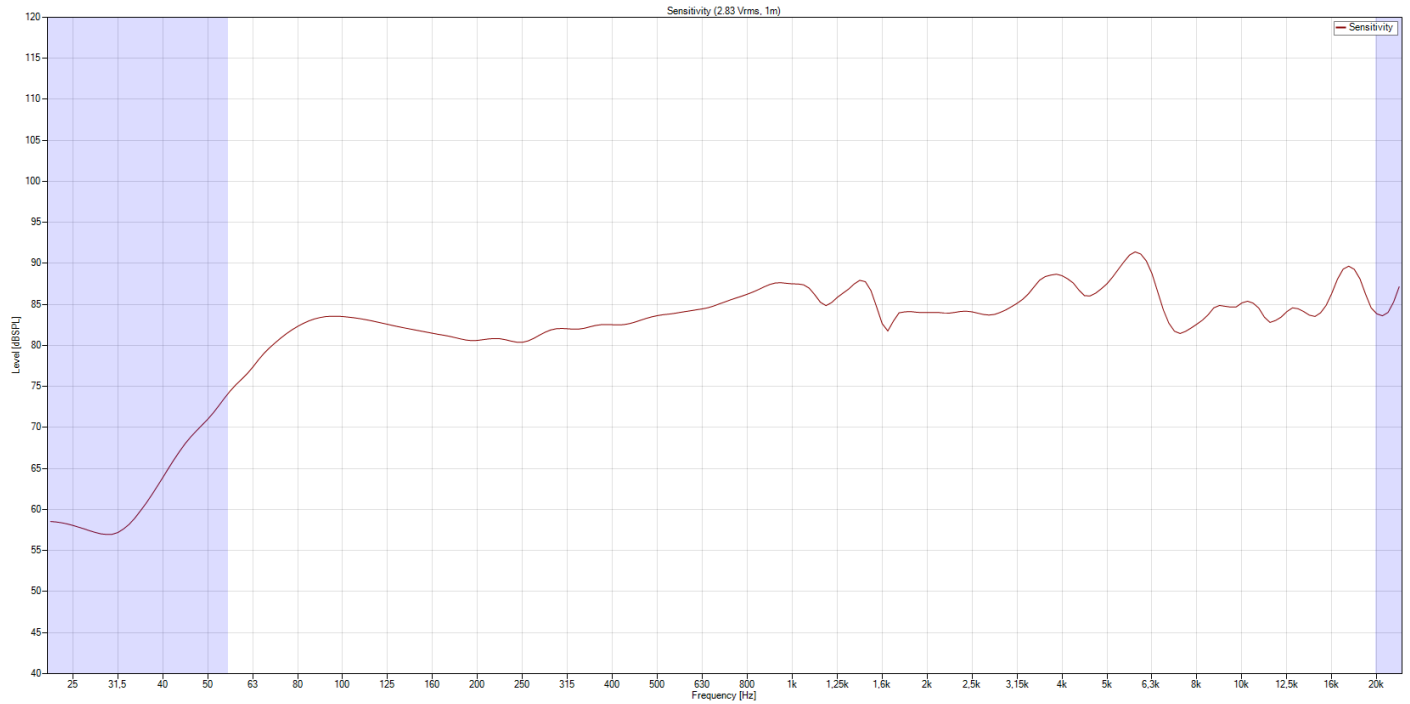

SPL Max

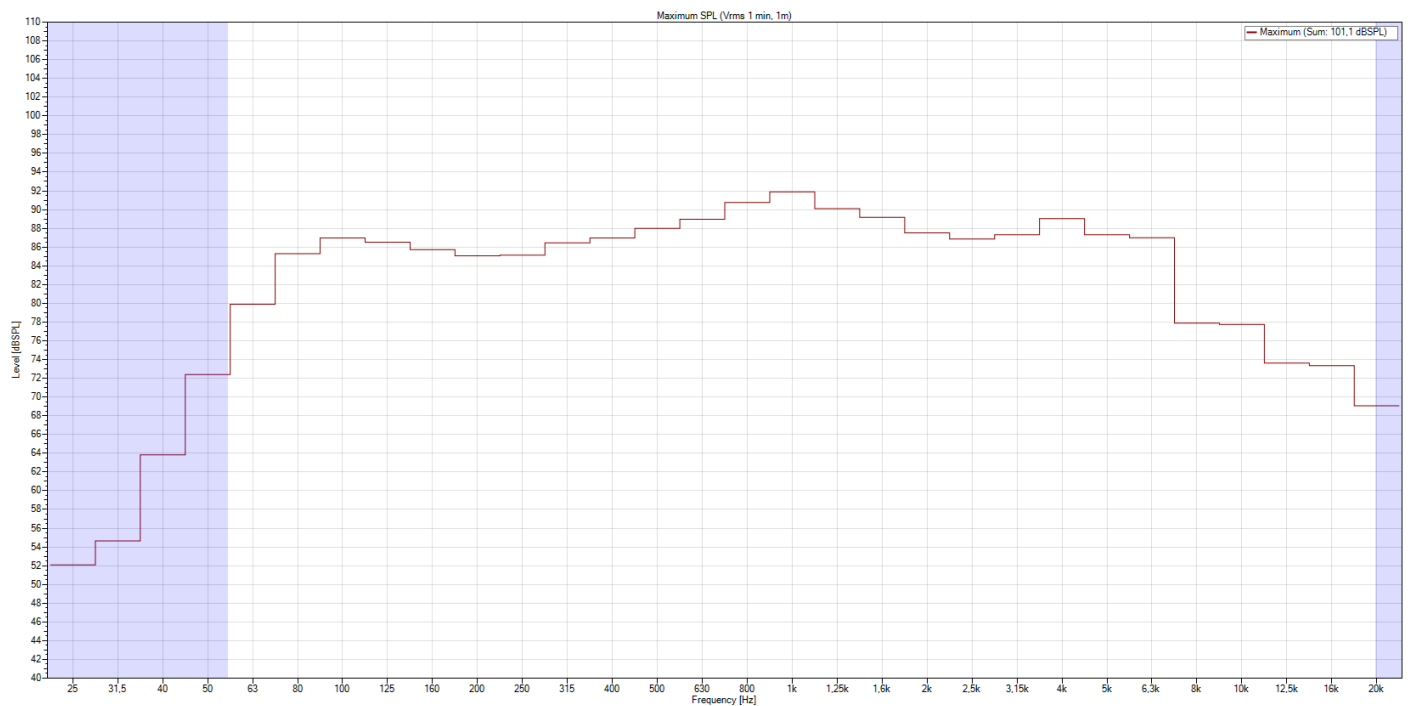

Isobar

Horizontal

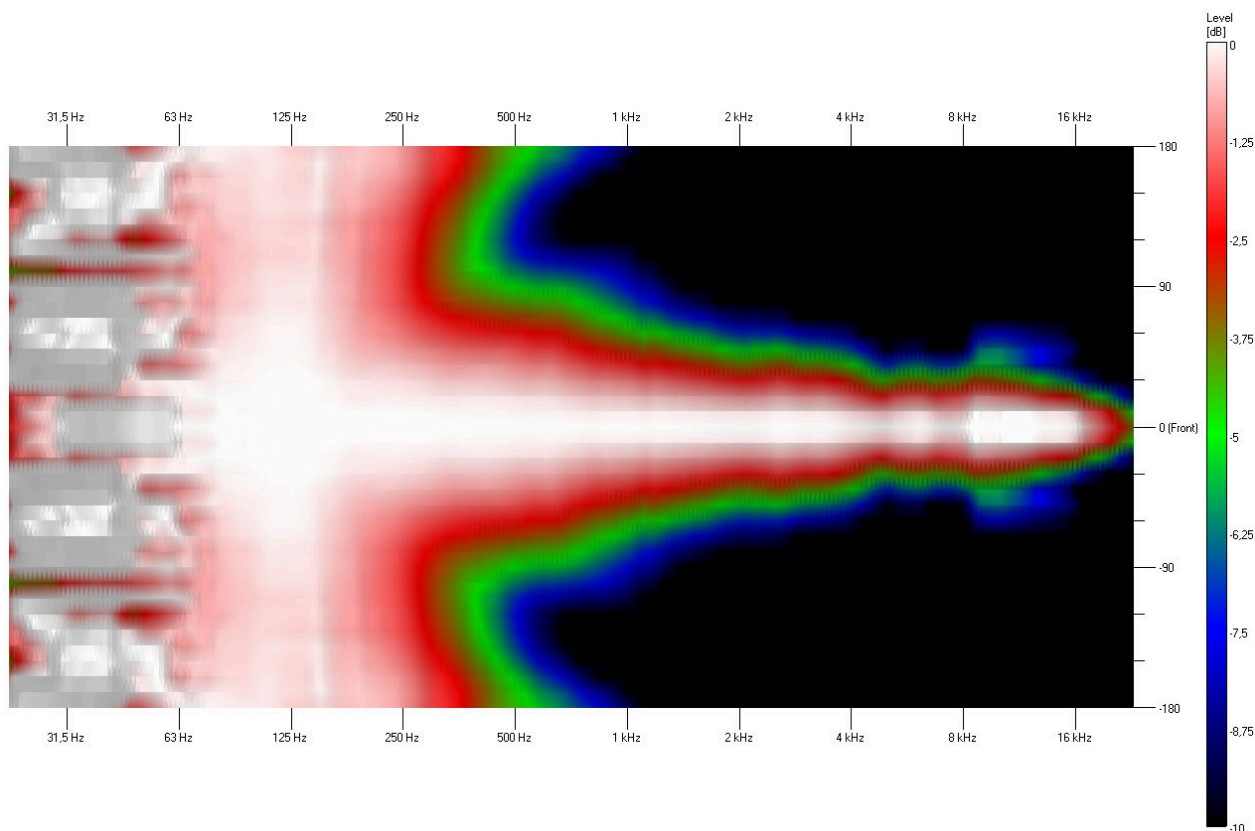

Vertical

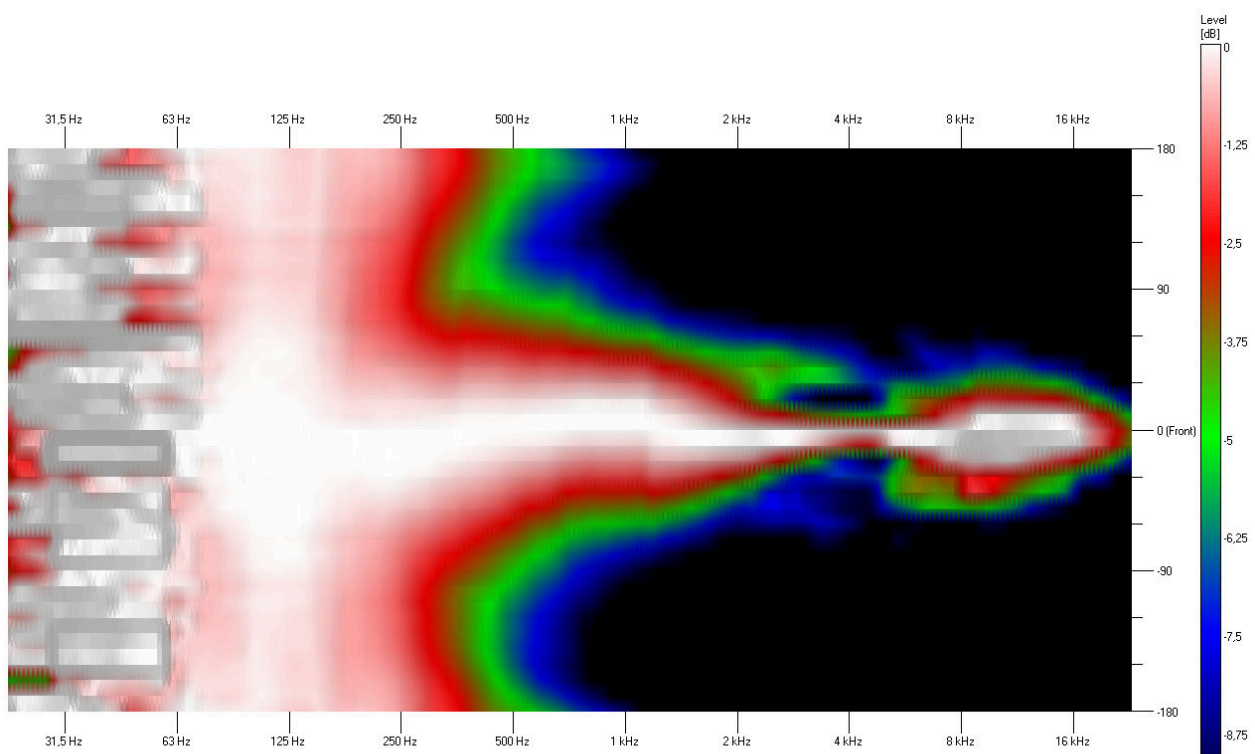

Polar Diagram

Polar Diagram 500Hz

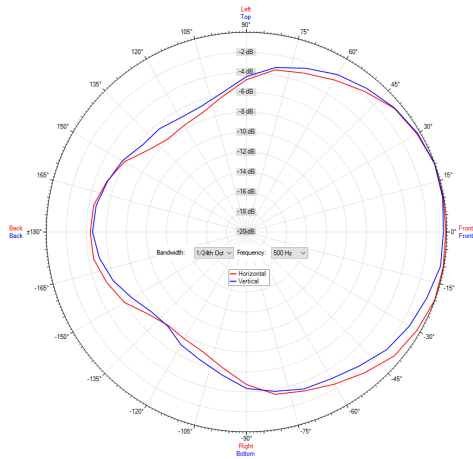

Polar Diagram 4000Hz

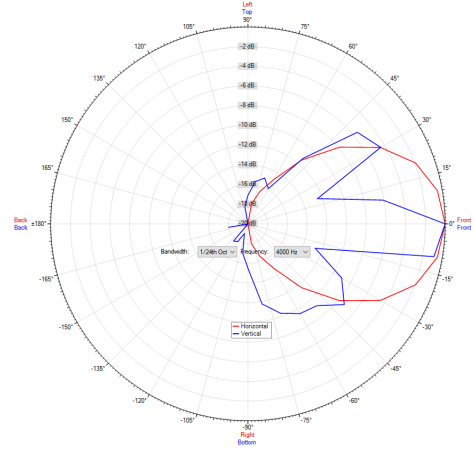

Polar Diagram 1000Hz

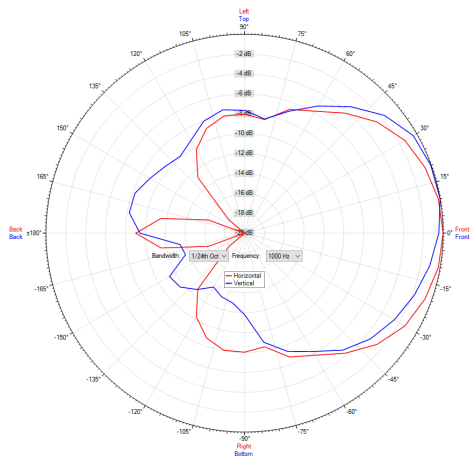

Polar Diagram 8000Hz

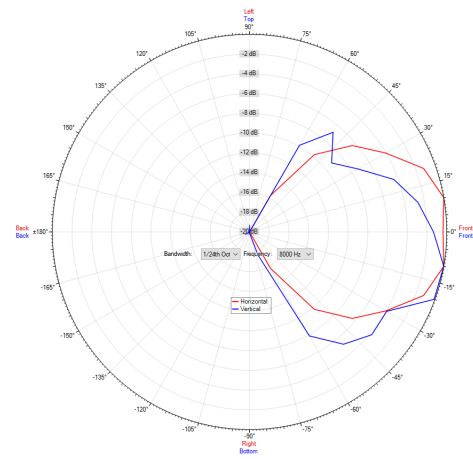

Polar Diagram 2000Hz

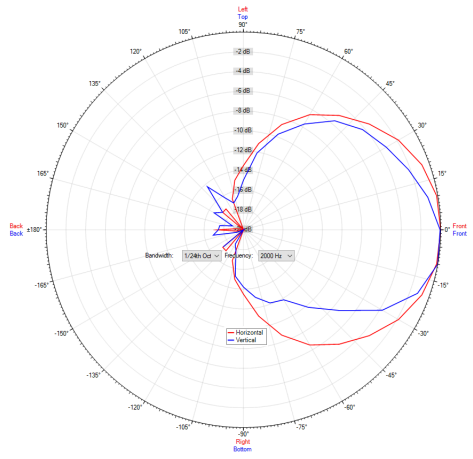

ic audio loudspeakers are tested and classified according to the IEC standard 60529 (degree of protection by enclosure) against the penetration of foreign objects and moisture. The classification is conforming to standards through characterization with a fixed code. This code consists of the letters IP (International Protection) followed by two digits. The first digit indicates the degree of protection against dust and the second digit the degree of protection against water. Please note that the testing of the products has been carried out in laboratory conditions which are not always 100% comparable with the conditions of different installation environments. This protection can be reduced due to normal wear and tear depending on the installation environment.

RoHS compliant (2011/65/EU)

The IP rating specified is based on ic audio test results, not on CNBOP-PIB test results. Certification only verifies the minimum requirements for EN54-24 compliance.



Artikel Nr. : 20122648

Packing Unit: 4

