

WA-S 06-100/T-EN54



- high sound pressure level
- frameless design
- flexible mounting



EN 54-24:2008
Ref. Nr.: 002-23
ID-Code: SAA-LS02
1438-CPR-0984

ic audio GmbH, Boehringerstraße 14a,
D-68307 Mannheim, Germany

CE-Symbol gemäß Richtlinie 93/68EWG

A uniquely designed ultra-slim wall speaker for limited space and unobtrusive installations. The WA-S 06-100/T-EN54 delivers excellent sound quality with an outstanding look.

The 6W full range 100mm speaker convinces through high-quality design and resilience. The impact-resistant, UV-resistant, ABS plastic housing in RAL 9016 assures enduring stability. It features a magnetically attached grille – discreet and easy maintenance.

Fast and easy installation by WAGO 221 connector.

The speaker is protected against the risks of environmental influences with protection class IP 21. It is also impregnated against moisture.

Thanks to its flexible mounting positions, 3 orientations are possible:

1. Horizontal alignment on the wall
2. Horizontal alignment between two walls and the ceiling
3. Corner mount

Product	WA-S 06-100/T-EN54
Artikel Nr.	20227870

Acoustics

Power	6/3 /1.5 W
Impedance (100V)	1667/3333 /6667 ohm
Speaker ø	100 mm
Frequency Range	315 - 15.500 Hz
Frequency Response	185 - 17.500 Hz
SPL 1W/1m, peak	91,0 dB
SPL 1W/4m, peak	79,0 dB
SPL Pmax/4m, peak	86,0 dB
SPL IEC268-5, 1W/1m	91,8 dB
SPL IEC268-5, Pmax/1m	94,2 dB
Sensitivity EN54-24, 1W/1m	92,3 dB
Sensitivity EN54-24, 1W/4m	80,3 dB
Dispersion -6dB, 500Hz	360° 360°
Dispersion -6dB, 1KHz	150° 265°
Dispersion -6dB, 2KHz	110° 100°
Dispersion -6dB, 4KHz	102° 102°

Connections and Housing

Connector	WAGO 221 connector
Terminal Diameter	2,3 mm
Maximum Cable Passage	4 mm ²
Temperature Range	-10 / +55 C°
Type A/B	A
Dimensions	225X150X45 mm
Weight (net)	0,61 kg
Housing	ABS
Colour	RAL 9016
Mounting	screws
IP Rating	IP21

Certification

Ref. Nr.	002-23
ID-Code	SAA-LS02
Certificate Number	1438-CPR-0984

Product Attributes



Technical Drawing

ic audio

WA-S 06-100/T-EN54

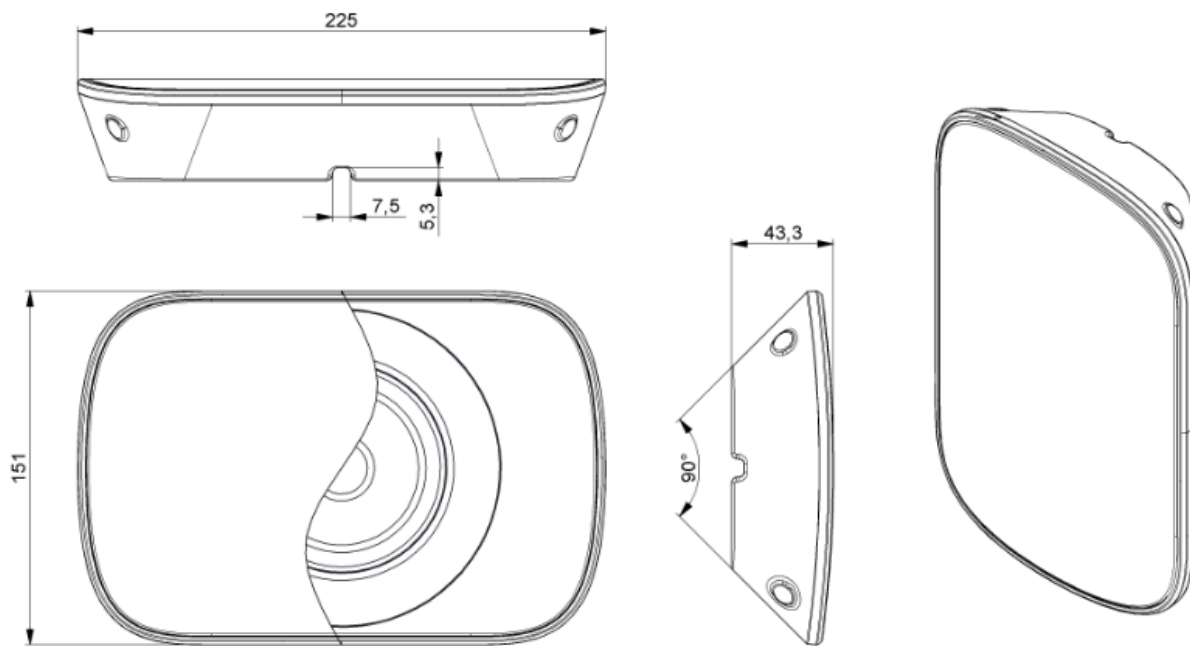

all dimensions are in mm

Frequency Response Diagram

Sensitivity

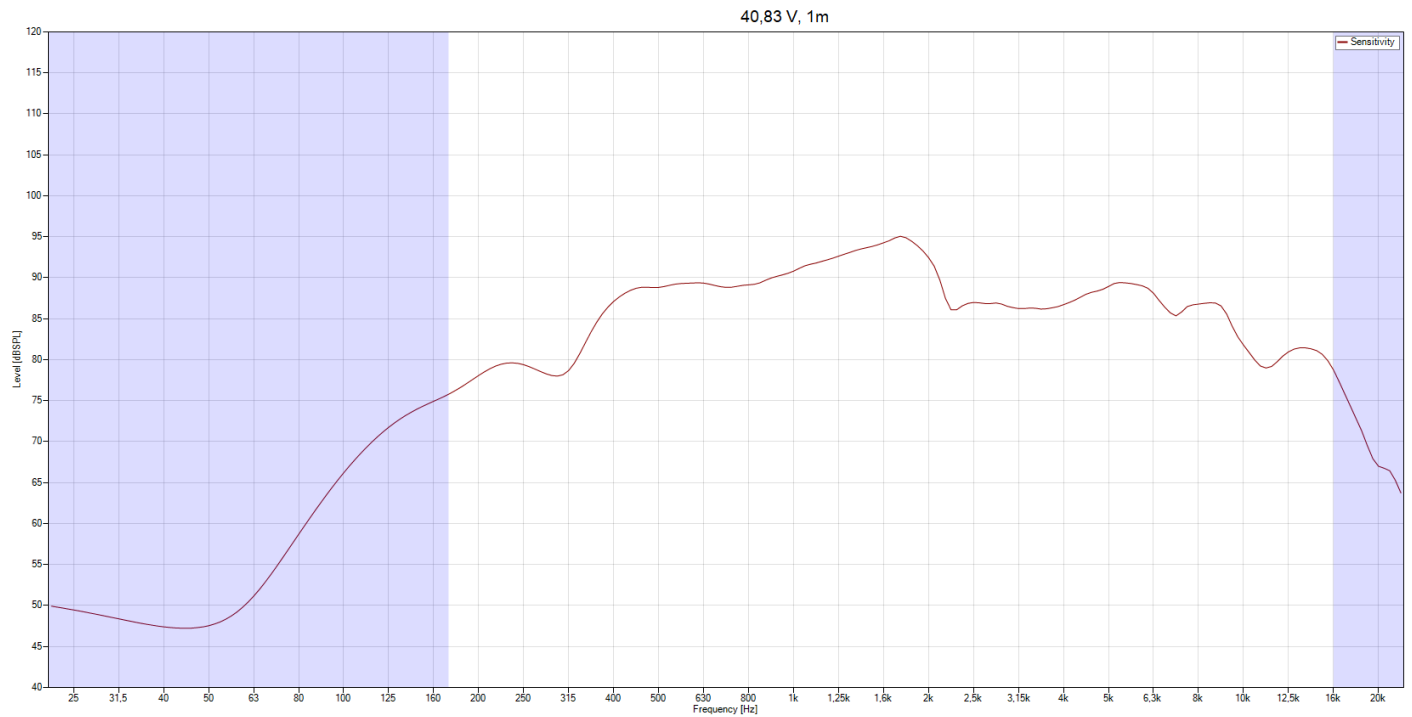

SPL Max

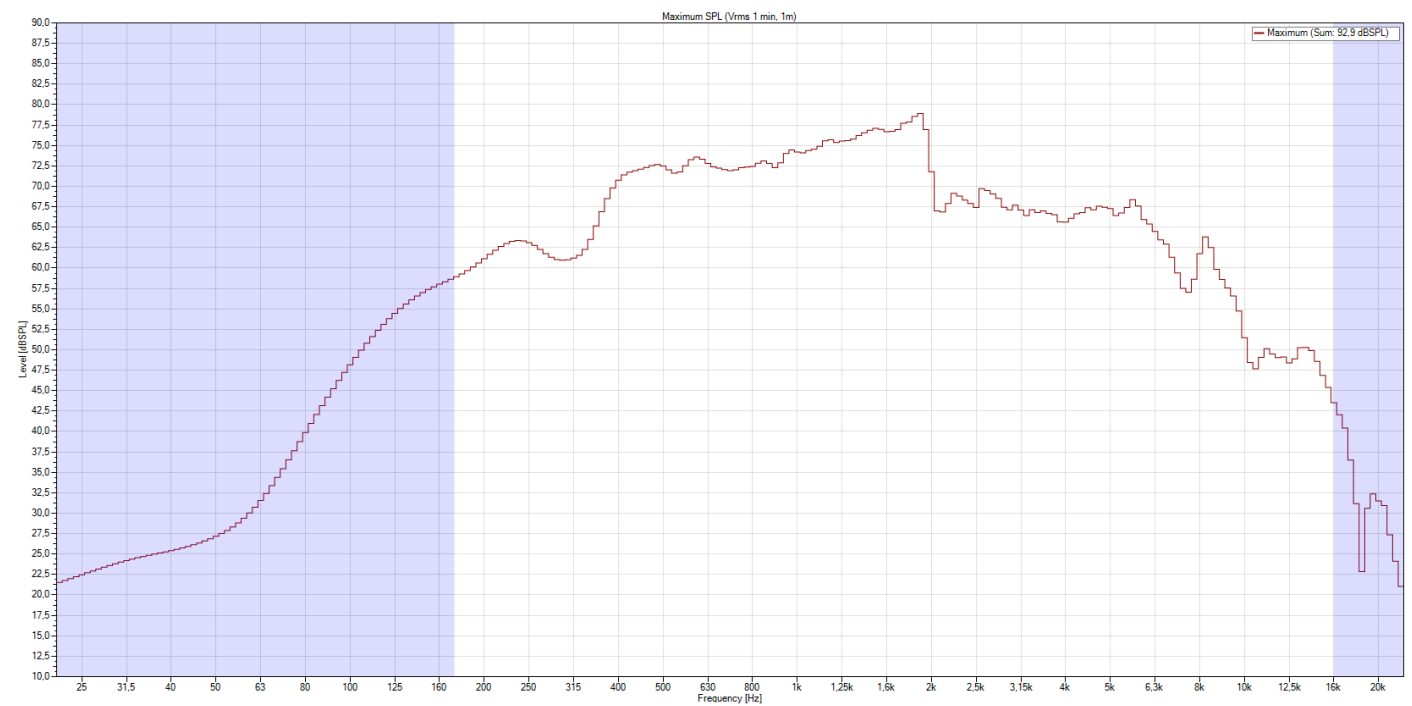

Isobar

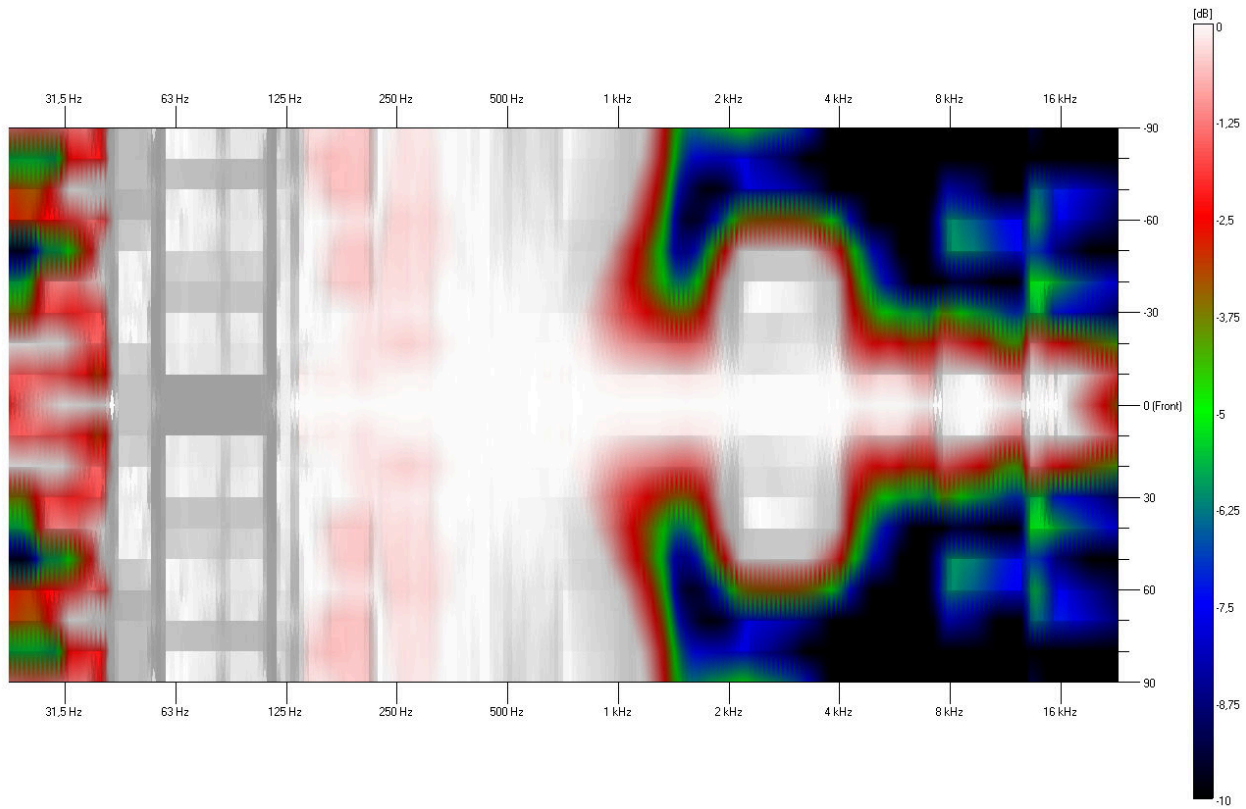

Polar Diagram

Polar Diagram 500Hz

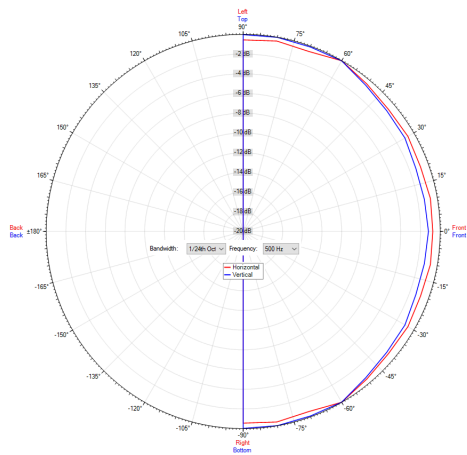

Polar Diagram 4000Hz

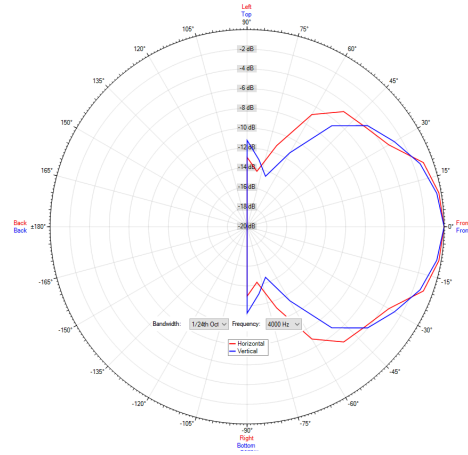

Polar Diagram 1000Hz

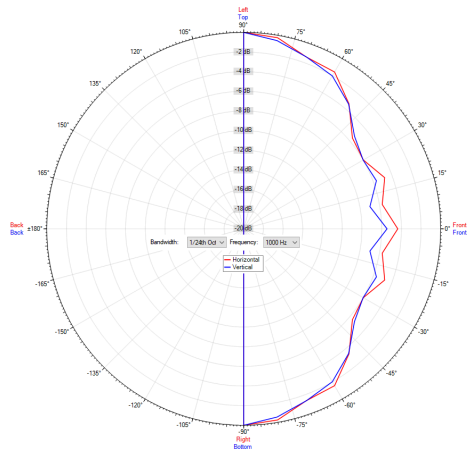

Polar Diagram 8000Hz

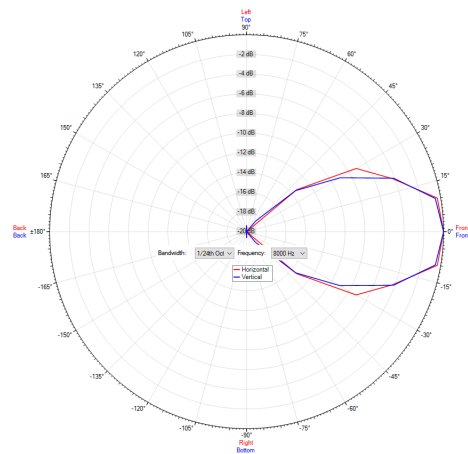

Polar Diagram 2000Hz

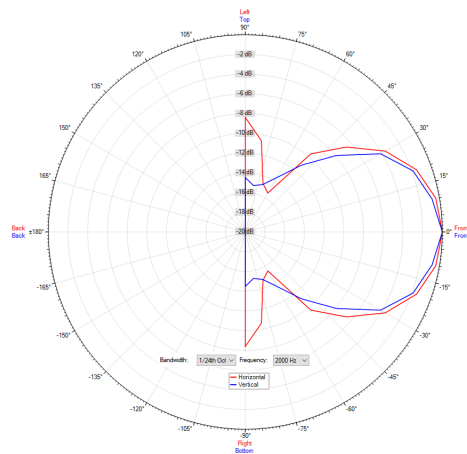

ic audio loudspeakers are tested and classified according to the IEC standard 60529 (degree of protection by enclosure) against the penetration of foreign objects and moisture. The classification is conforming to standards through characterization with a fixed code. This code consists of the letters IP (International Protection) followed by two digits. The first digit indicates the degree of protection against dust and the second digit the degree of protection against water. Please note that the testing of the products has been carried out in laboratory conditions which are not always 100% comparable with the conditions of different installation environments. This protection can be reduced due to normal wear and tear depending on the installation environment.

RoHS compliant (2011/65/EU)

The IP rating specified is based on ic audio test results, not on CNBOP-PIB test results. Certification only verifies the minimum requirements for EN54-24 compliance.



Artikel Nr. : 20227870

Packing Unit: 12

