

DA-S 20-130/T-EN54

- quick mounting
- aluminium housing
- BS 5839



EN 54-24:2008
Ref. Nr.: 002-13
ID-Code: SAA-LS02
1438-CPR-1000

24

ic audio GmbH, Boehringerstraße 14a,
D-68307 Mannheim, Germany

CE-Symbol gemäß Richtlinie 93/68EWG

The 20W powered speaker is equipped with a 130mm full-range loudspeaker and a 100V line transformer with 4 power adjustments. A robust powder-coated aluminium housing in RAL 9010, and a solid aluminium mounting bracket ensure the permanent installation of this speaker. For additional reliability, a 2-pin ceramic block and a thermal fuse are provided in a junction box and the speaker chassis is impregnated against wetness.

The speaker is also secured with the high protection class IP 65 against the risks of environmental influences. The speaker is compliant with the British Standard BS 5839, Part 8.

Optionally available is a mast bracket (MB) for approx. 200mm mast diameter.

Product	DA-S 20-130/T-EN54
Artikel Nr.	20102185

Acoustics

Power	20/15/10/5 W
Impedance (100V)	500/667/1000/2000 ohm
Speaker \varnothing	130 mm
Frequency Range	800 - 16.700 Hz
Frequency Response	150 - 20.000 Hz
SPL 1W/1m, peak	103,2 dB
SPL 1W/4m, peak	91,2 dB
SPL Pmax/4m, peak	104,2 dB
SPL IEC268-5, 1W/1m	92,0 dB
SPL IEC268-5, Pmax/1m	105,0 dB
Sensitivity EN54-24, 1W/1m	92,3 dB
Sensitivity EN54-24, 1W/4m	80,3 dB
Dispersion -6dB, 500Hz	h/v 360°
Dispersion -6dB, 1KHz	h/v 210°
Dispersion -6dB, 2KHz	h/v 105°
Dispersion -6dB, 4KHz	h/v 55°

Connections and Housing

Connector	2-pin ceramic block
Terminal Diameter	3,2 mm
Maximum Cable Passage	8 mm ²
Temperature Range	-25 / +70 C°
Type A/B	B
Dimensions	140x163 mm
Weight (net)	2,52 kg
Housing	aluminium
Colour	RAL 9010
Mounting	Mounting bracket
IP Rating	IP65

Certification

Ref. Nr.	002-13
ID-Code	SAA-LS02
Certificate Number	1438-CPR-1000

Product Attributes



Technical Drawing

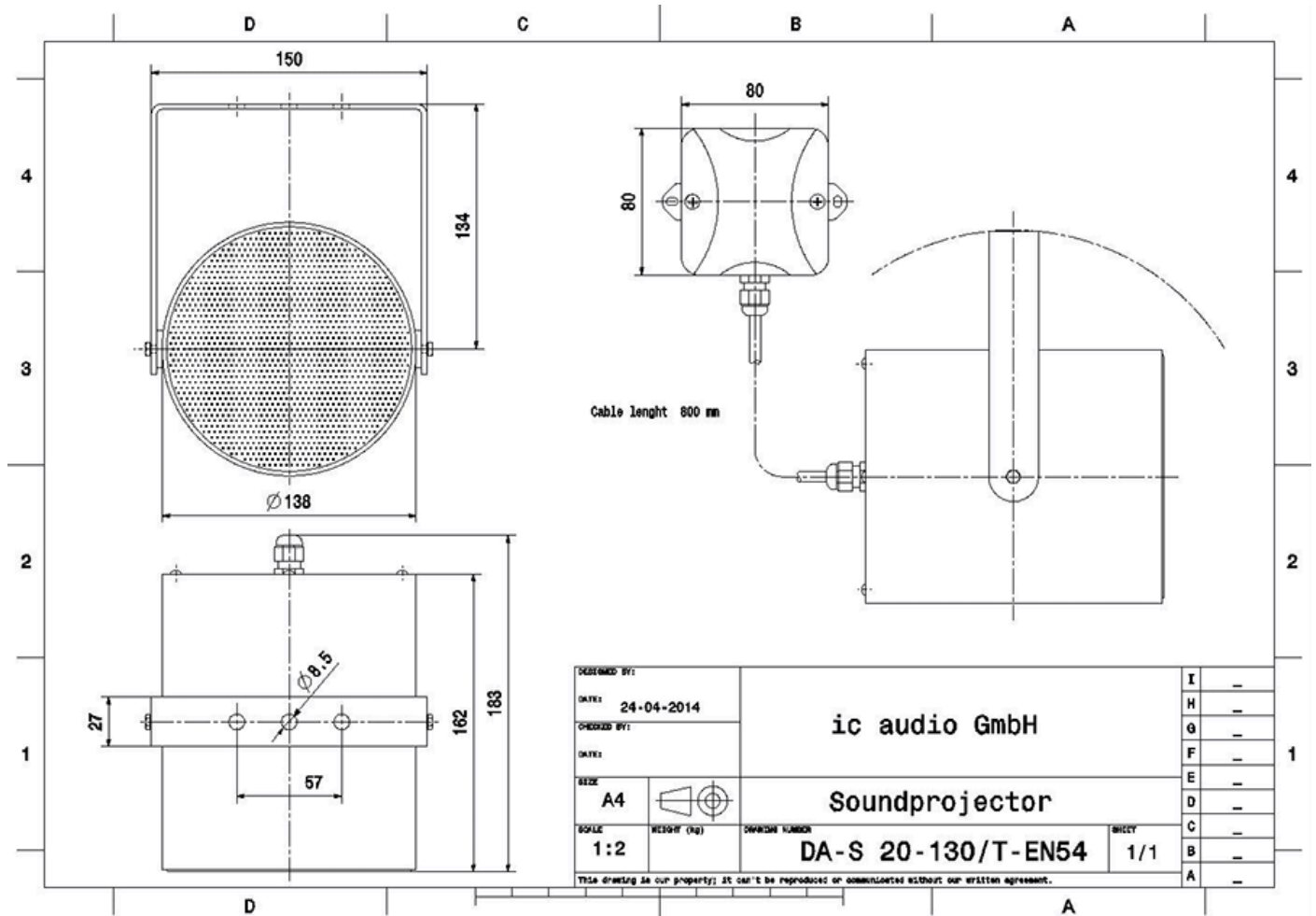

Frequency Response Diagram

Sensitivity

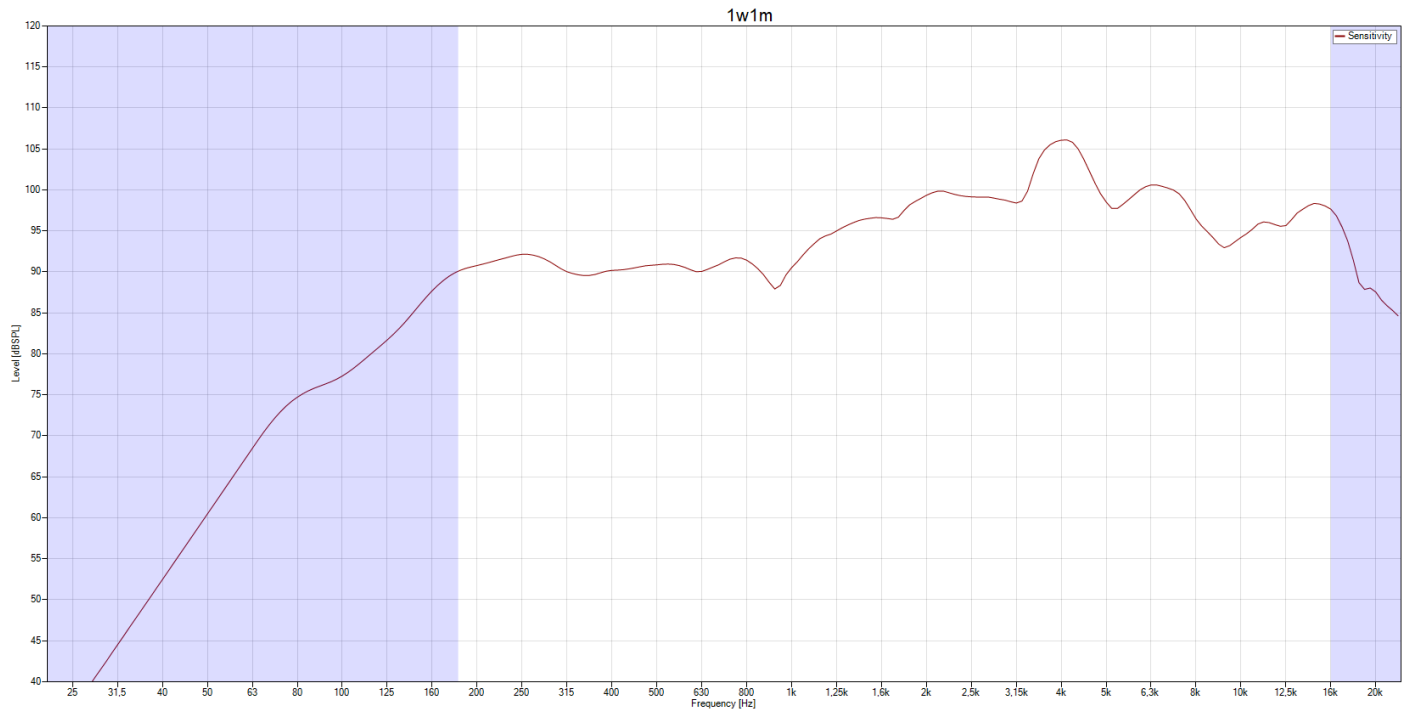

SPL Max

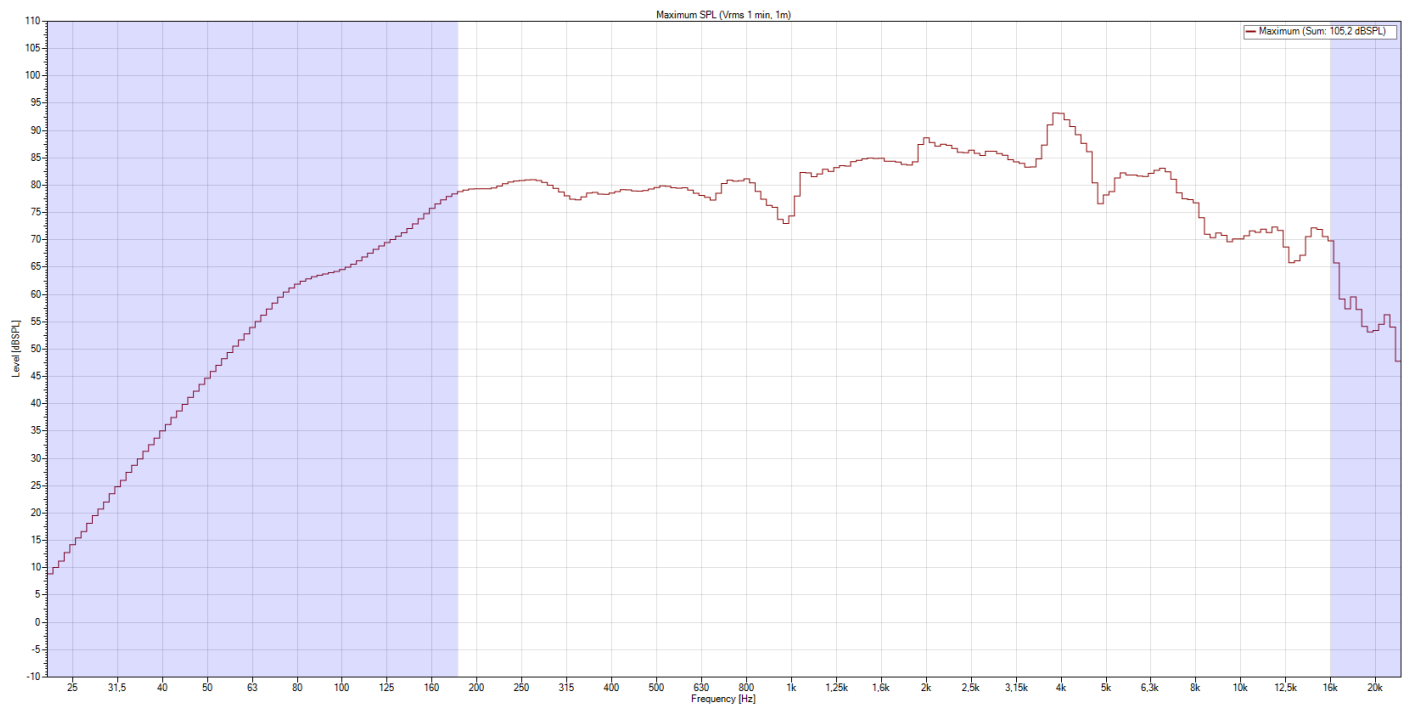

Isobar

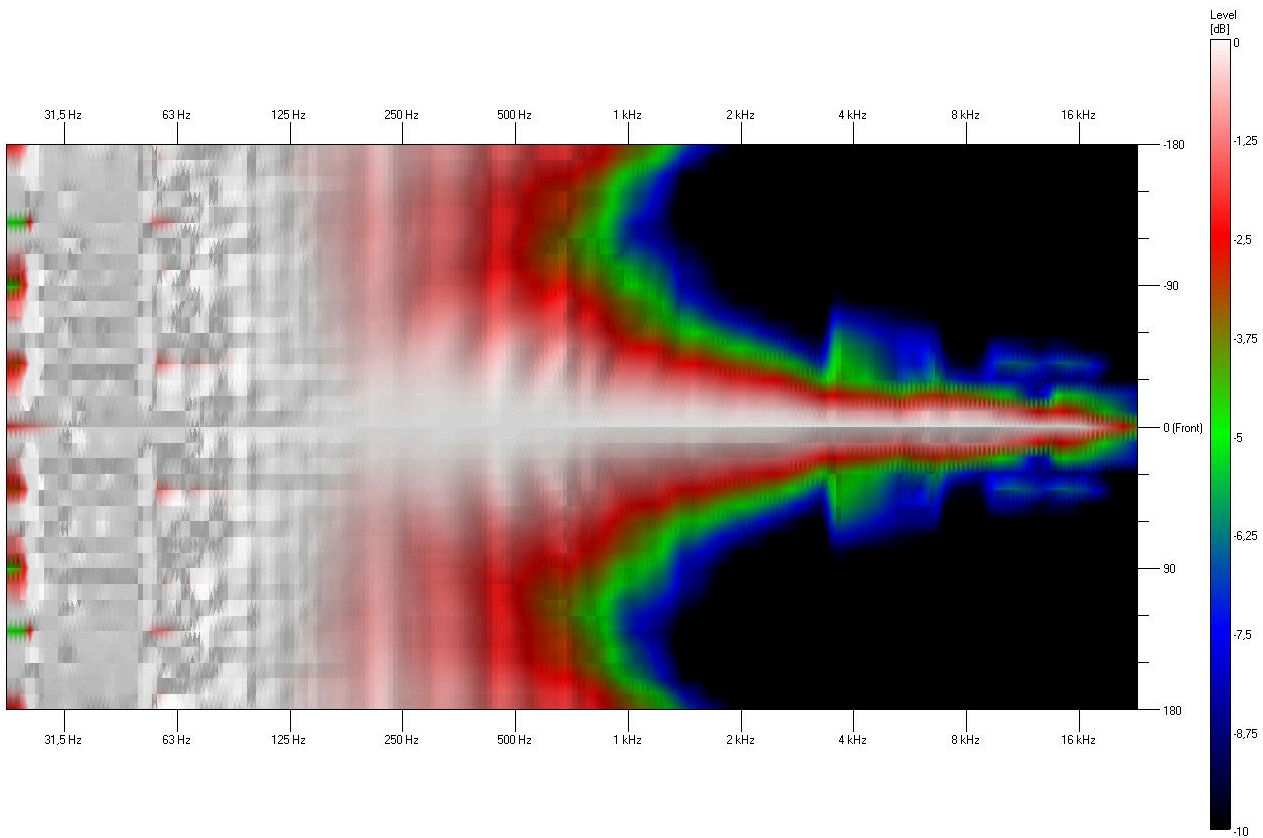

Polar Diagram

Polar Diagram 500Hz

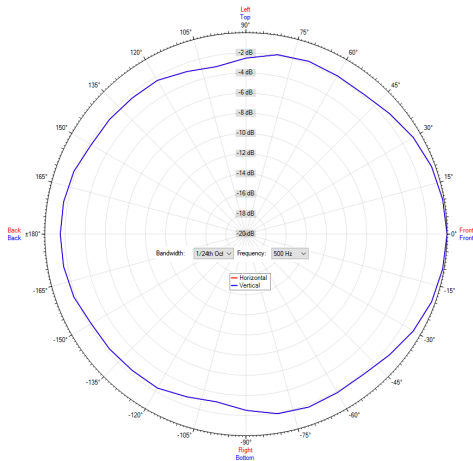

Polar Diagram 4000Hz

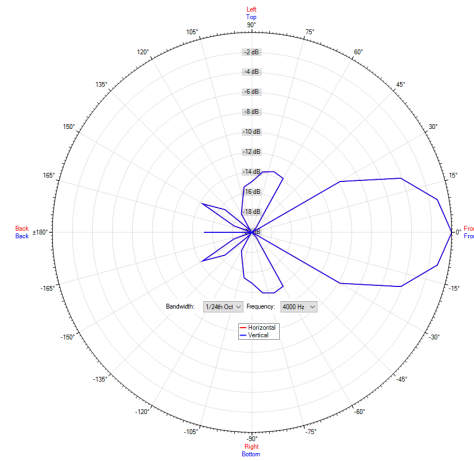

Polar Diagram 1000Hz

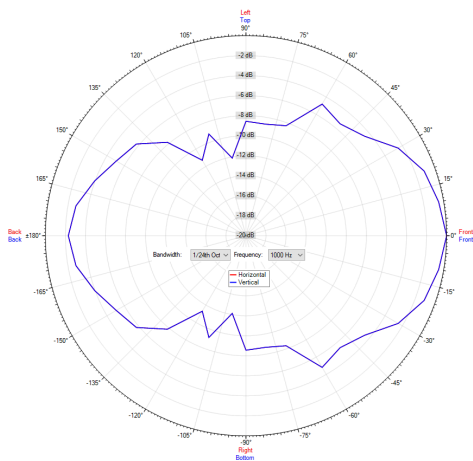

Polar Diagram 8000Hz

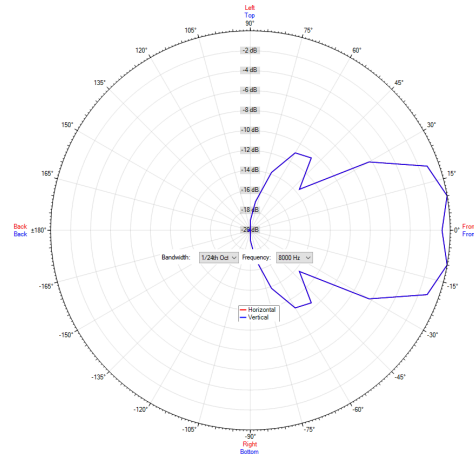

Polar Diagram 2000Hz

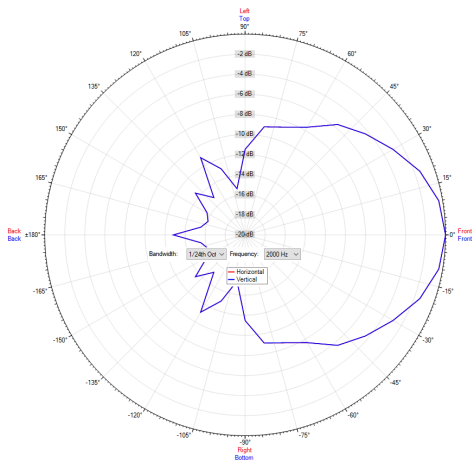

ic audio loudspeakers are tested and classified according to the IEC standard 60529 (degree of protection by enclosure) against the penetration of foreign objects and moisture. The classification is conforming to standards through characterization with a fixed code. This code consists of the letters IP (International Protection) followed by two digits. The first digit indicates the degree of protection against dust and the second digit the degree of protection against water. Please note that the testing of the products has been carried out in laboratory conditions which are not always 100% comparable with the conditions of different installation environments. This protection can be reduced due to normal wear and tear depending on the installation environment.

RoHS compliant (2011/65/EU)

The IP rating specified is based on ic audio test results, not on CNBOP-PIB test results. Certification only verifies the minimum requirements for EN54-24 compliance.



Artikel Nr. : 20102185
Packing Unit: 8

