

## WA 10-165/T-EN54

- Softline design
- Impact-resistant housing
- BS 5839



EN 54-24:2008  
Ref. Nr.: 007-13  
ID-Code: SAA-LS07  
1438-CPR-0231

ic audio GmbH, Boehringerstraße 14a,  
D-68307 Mannheim, Germany

CE-Symbol gemäß Richtlinie 93/68EWG

The 10W powered speaker is equipped with a 165mm full-range loudspeaker chassis and a 100V transformer with 4 power adjustments. The high-density, shock-resistant RAL 9010 MDF wood housing provides a low-distortion sound. A robust front grille made of steel guarantees enduring stability.

A 2-pin ceramic block and a thermal fuse provide additional reliability. The speaker chassis is impregnated against wetness.

The speaker is secured with the high protection class IP 54 against the risks of environmental influences. It is also compliant with the British Standard BS 5839, Part 8.

The proven spring snap fastener on the rear wall ensures quick wall mounting.

Product	WA 10-165/T-EN54
Artikel Nr.	20184119

## Acoustics

Power	10/6/3/1,5 W
Impedance (100V)	1000/1667/3333/6667 ohm
Speaker $\varnothing$	165 mm
Frequency Range	197 - 21.900 Hz
Frequency Response	175 - 23.500 Hz
SPL 1W/1m, peak	100,6 dB
SPL 1W/4m, peak	88,6 dB
SPL IEC268-5, 1W/1m	93,0 dB
SPL IEC268-5, Pmax/1m	100,6 dB
Sensitivity EN54-24, 1W/1m	93,0 dB
Sensitivity EN54-24, 1W/4m	81,0 dB
Dispersion -6dB, 500Hz	h=180° v=180°
Dispersion -6dB, 1KHz	h=160° v=160°
Dispersion -6dB, 2KHz	h=100° v=100°
Dispersion -6dB, 4KHz	h=60° v=60°

## Connections and Housing

Connector	2-pin ceramic block
Terminal Diameter	3,2 mm
Maximum Cable Passage	8 mm <sup>2</sup>
Temperature Range	-10 / +55 °C
Type A/B	A
Dimensions	253x194x82 mm
Weight (net)	1,86 kg
Housing	MDF
Colour	RAL 9010
Mounting	spring clamp
IP Rating	IP54

## Certification

Ref. Nr.	007-13
ID-Code	SAA-LS07
Certificate Number	1438-CPR-0231

## Product Attributes



## Technical Drawing

 **ic audio**

WA 10-165/T-EN54

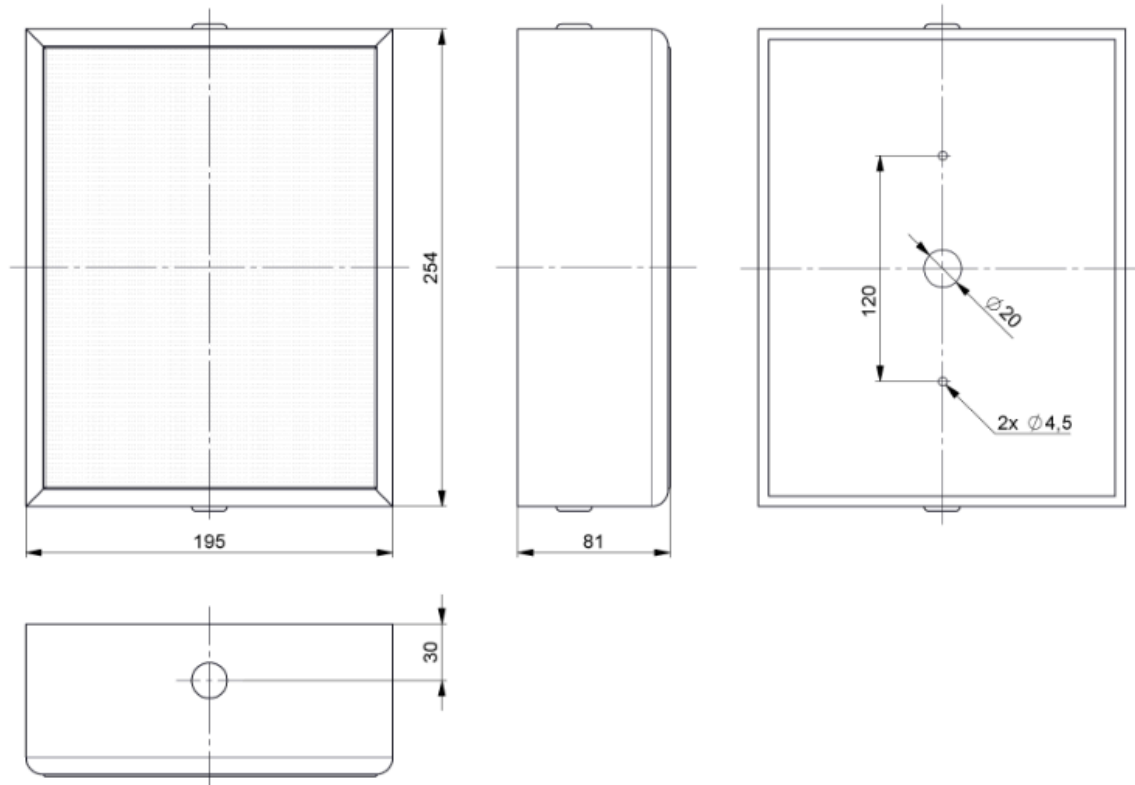

all dimensions are in mm

## Frequency Response Diagram

### Sensitivity

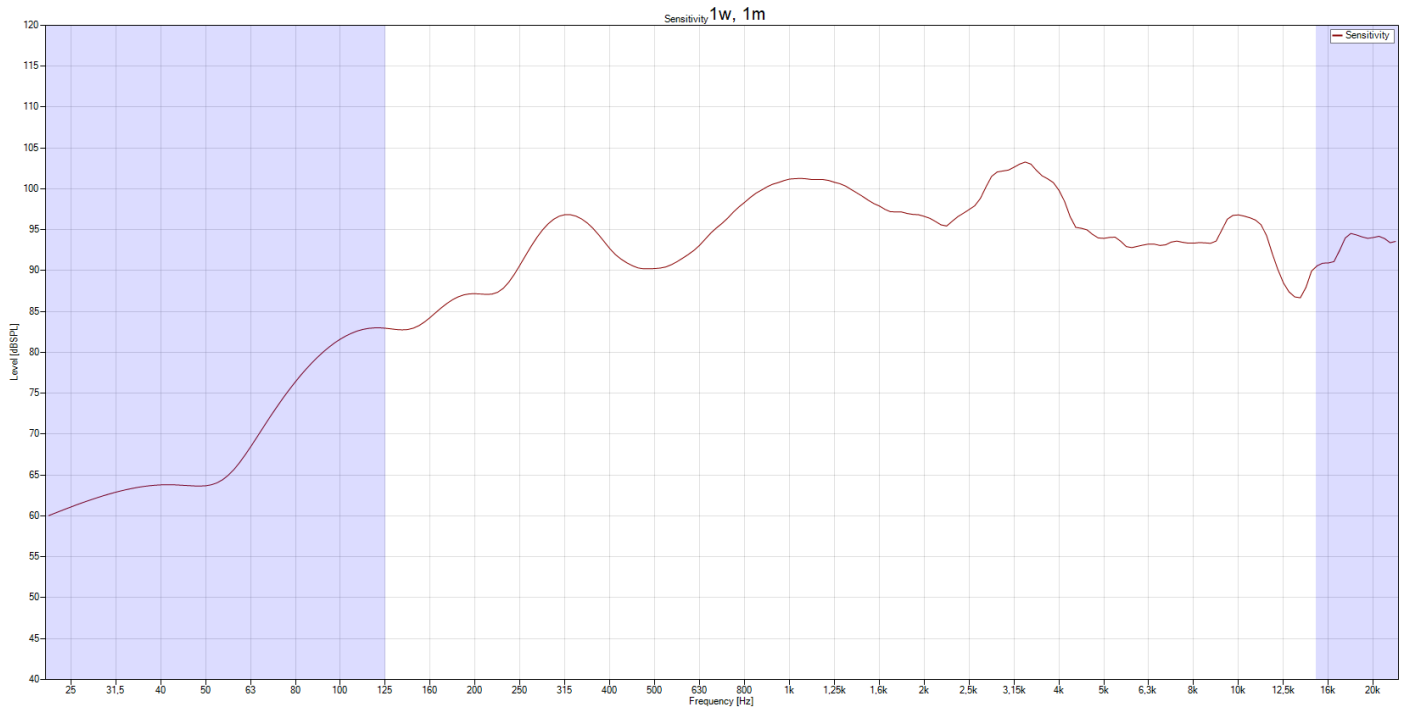

### SPL Max

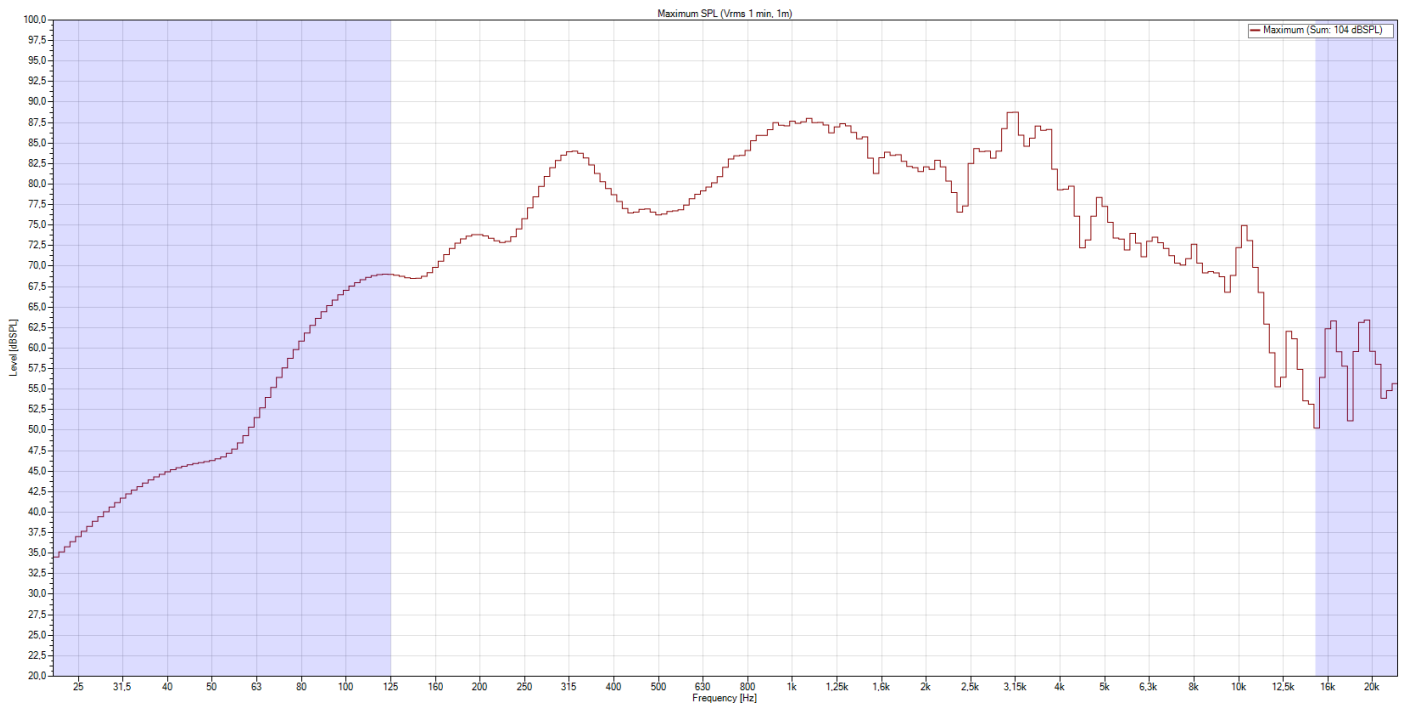

### Isobar

#### Horizontal

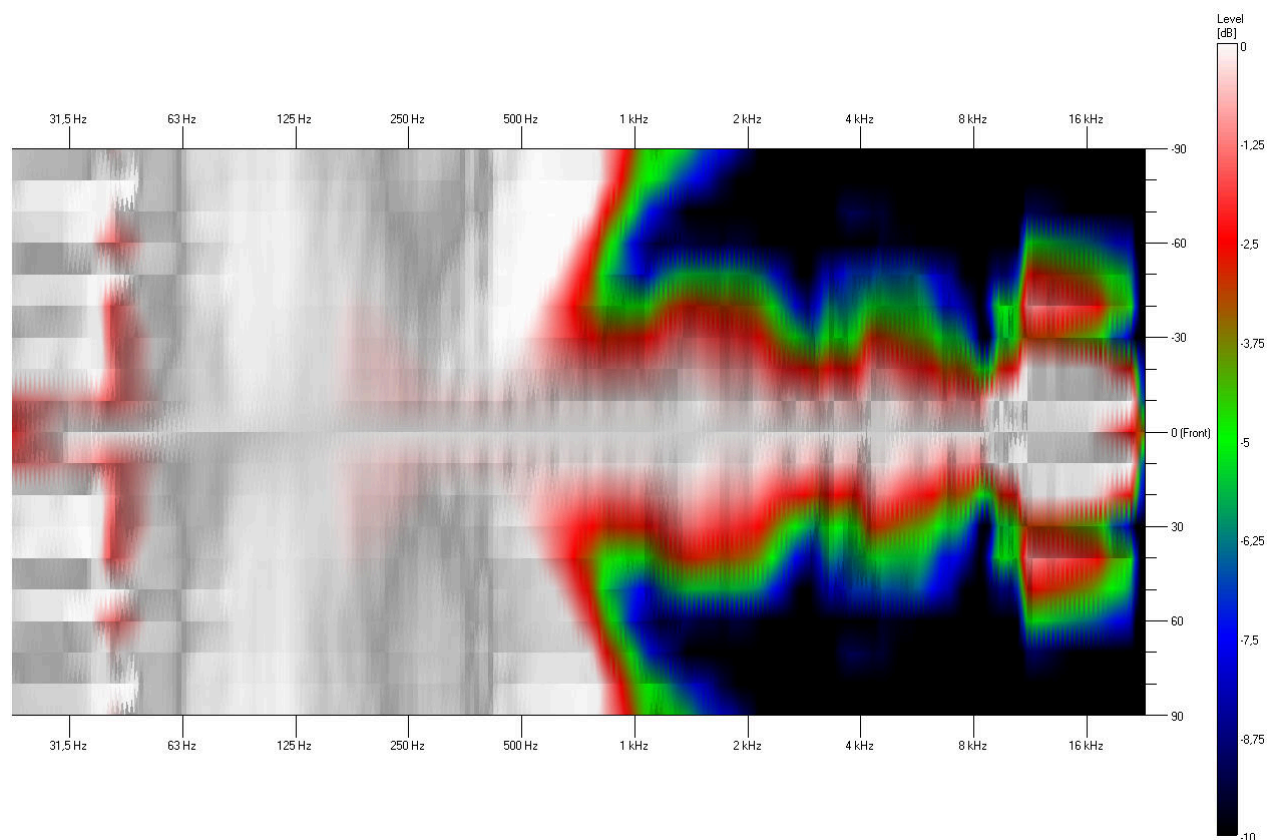

#### Vertical

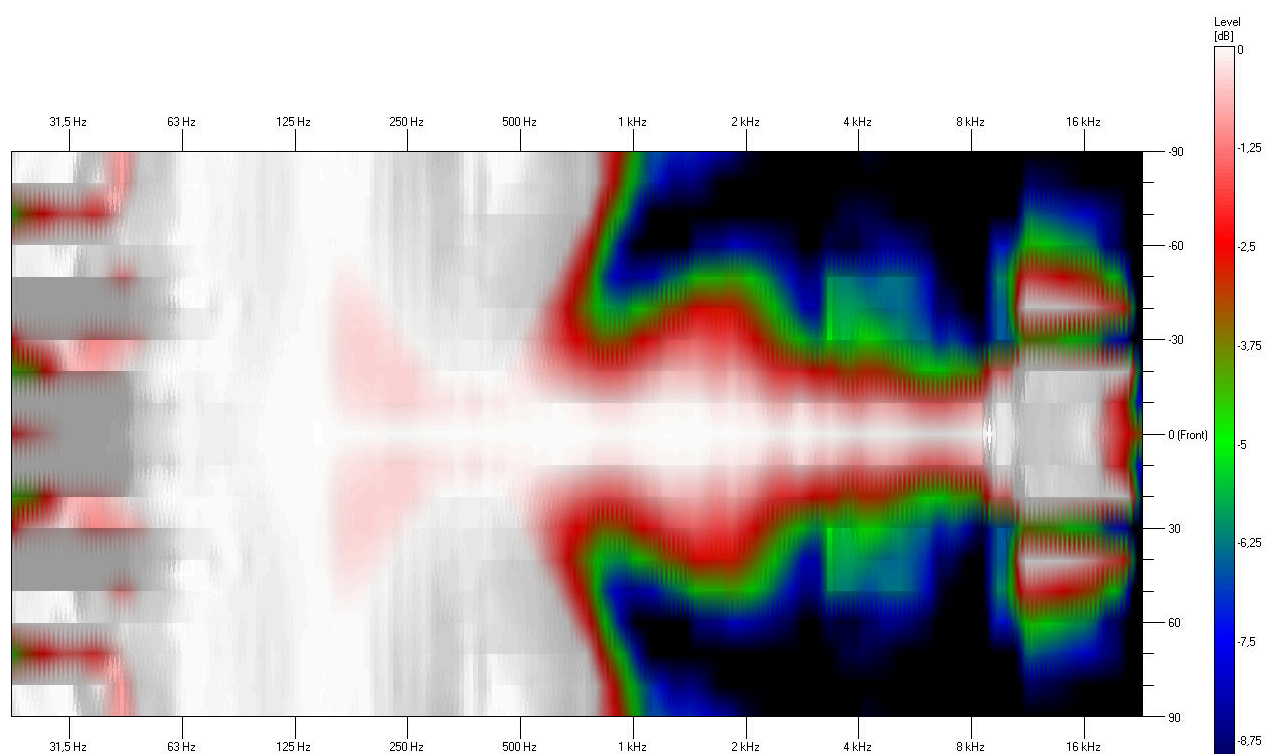

### Polar Diagram

Polar Diagram 500Hz

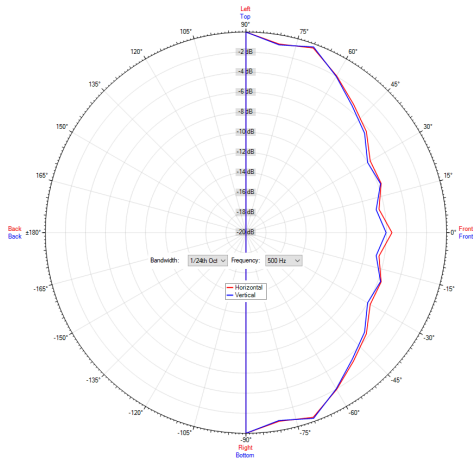

Polar Diagram 4000Hz

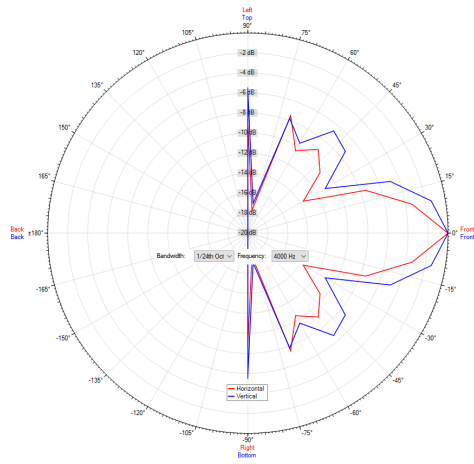

Polar Diagram 1000Hz

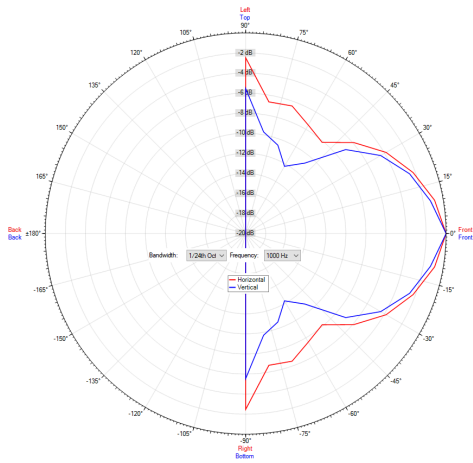

Polar Diagram 8000Hz

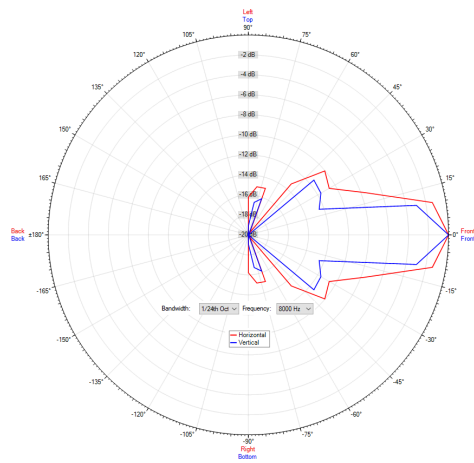

Polar Diagram 2000Hz

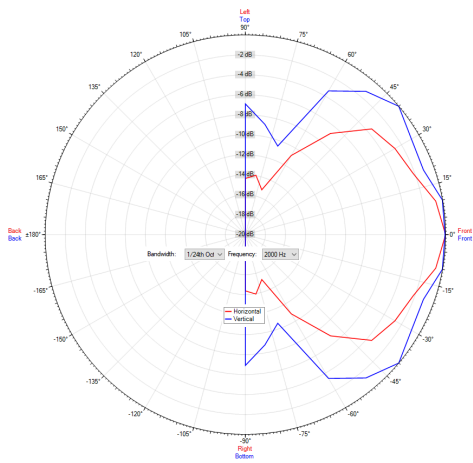

ic audio loudspeakers are tested and classified according to the IEC standard 60529 (degree of protection by enclosure) against the penetration of foreign objects and moisture. The classification is conforming to standards through characterization with a fixed code. This code consists of the letters IP (International Protection) followed by two digits. The first digit indicates the degree of protection against dust and the second digit the degree of protection against water. Please note that the testing of the products has been carried out in laboratory conditions which are not always 100% comparable with the conditions of different installation environments. This protection can be reduced due to normal wear and tear depending on the installation environment.

RoHS compliant (2011/65/EU)

The IP rating specified is based on ic audio test results, not on CNBOP-PIB test results. Certification only verifies the minimum requirements for EN54-24 compliance.



Artikel Nr. : 20184119

Packing Unit: 8

