



DL-P 10-165/T SWF-EN54

- seawater proof
- flat design
- UV-resistant



EN 54-24:2008
 Ref. Nr.: 04-19
 ID-Code: SAA-LS11
 1438-CPR-0718

ic audio GmbH, Boehringerstraße 14a,
 D-68307 Mannheim, Germany

CE-Symbol gemäß Richtlinie 93/68EWG

Technical Data (Electrical)

Description	DL-P 10-165/T SWF-EN54
Power	10/6/3/1,5 W
Impedance (100V)	1000/1667/3333/6667 ohm
Frequency Range	50 - 24.000 Hz
Frequency Response	42 - 25.000 Hz
SPL IEC268-5, 1W/1m	88,8 dB
SPL EN54-24, Pmax/4m	86,2 dB
Sensitivity EN54-24, 1W/4m	78,9 dB
Dispersion -6dB, 500Hz	165°
Dispersion -6dB, 1KHz	165°
Dispersion -6dB, 2KHz	145°
Dispersion -6dB, 4KHz	65°

Please note: Because of many different types of ceiling materials and ceiling strengths we recommend to build in a sample of the speaker to match the requirements accurately.

Technical Data (Mechanical)

Dimensions	220x82 mm
IP Rating	IP54
Weight (net)	1,20 kg
Ceiling Cut-out	175 mm
Temperature Range	-25 / +70 C°
Mounting	Quick fit mounting
Connector	5-pin terminal
Terminal Diameter	3,2 mm
Maximum Cable Passage	8 mm ²
Colour	RAL 9016

Product Attributes



Technical Diagrams

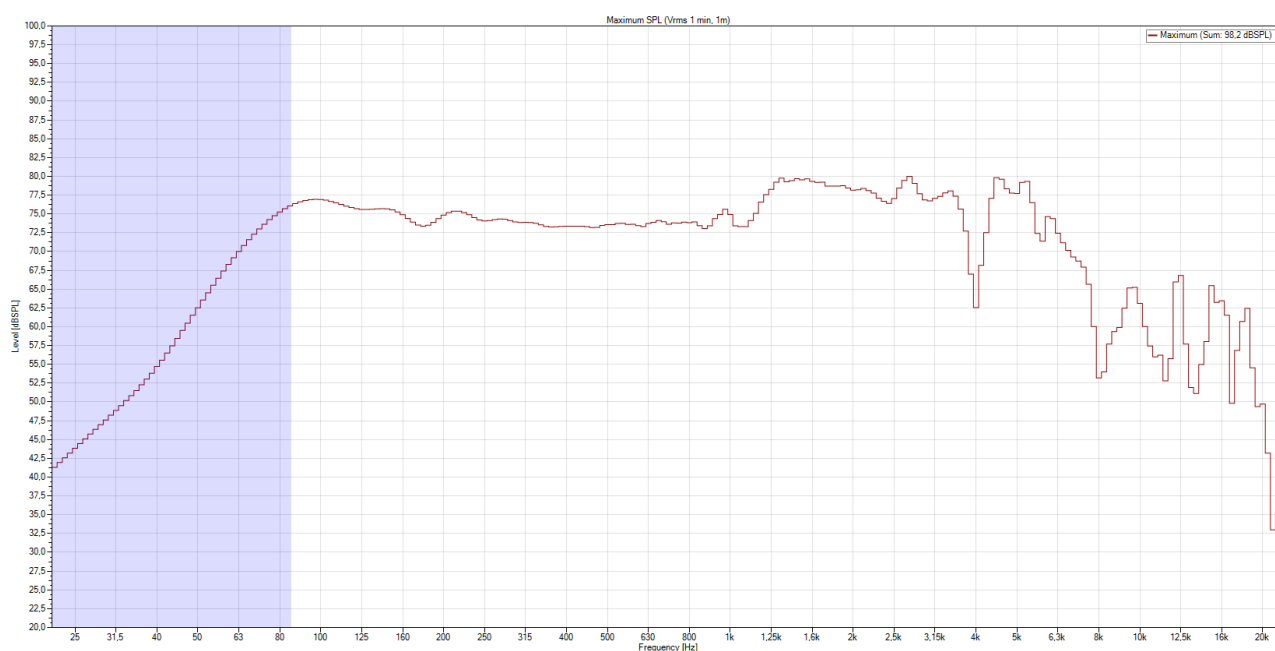

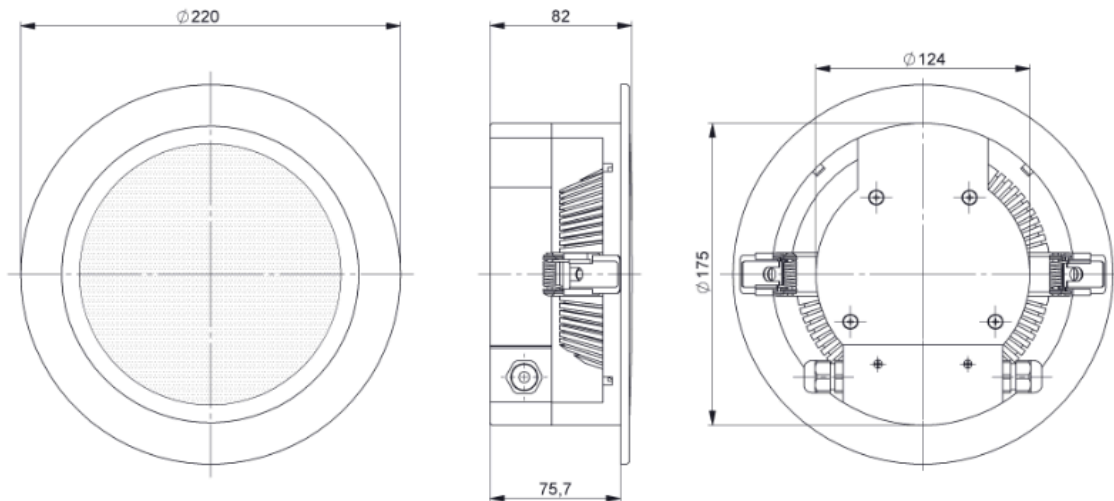
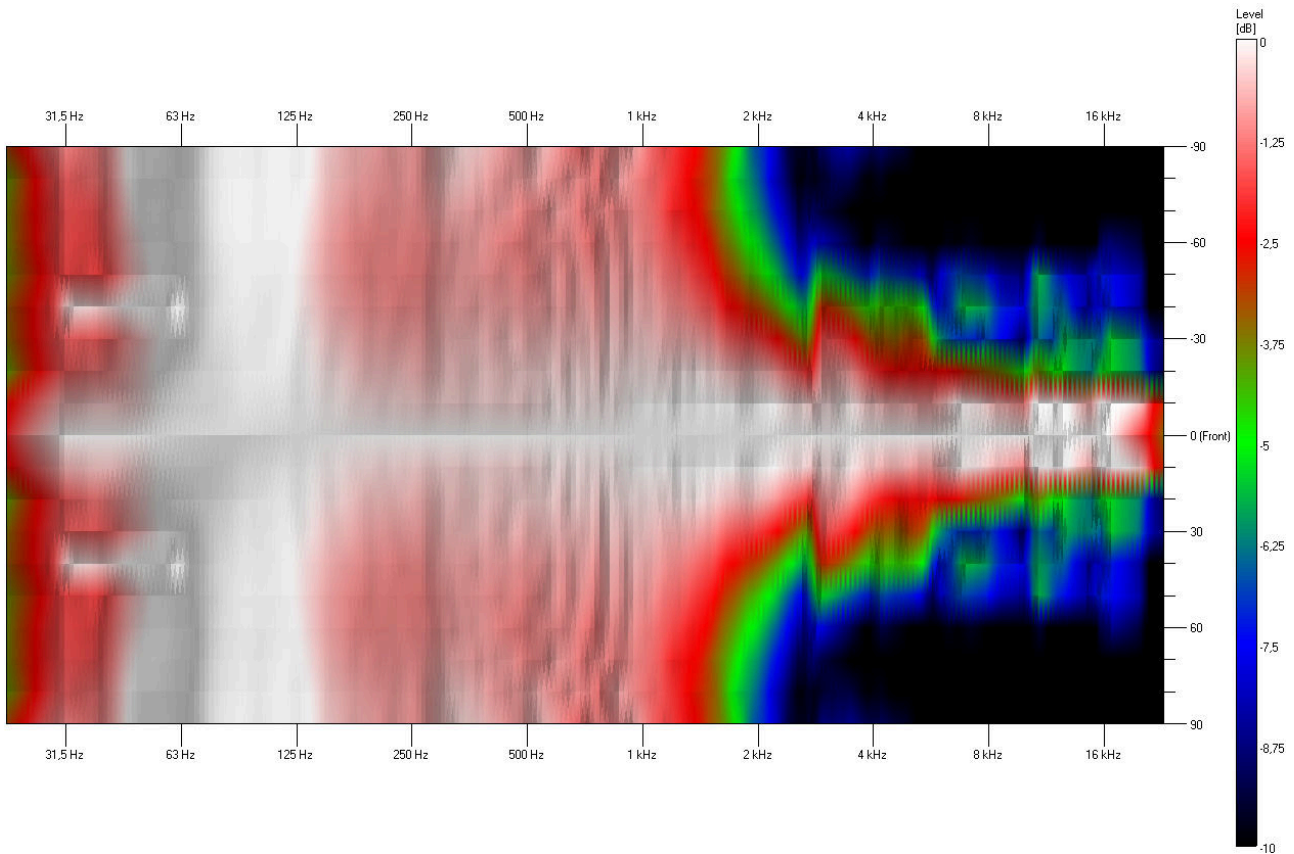

all dimensions are in mm

Frequency Response Diagrams

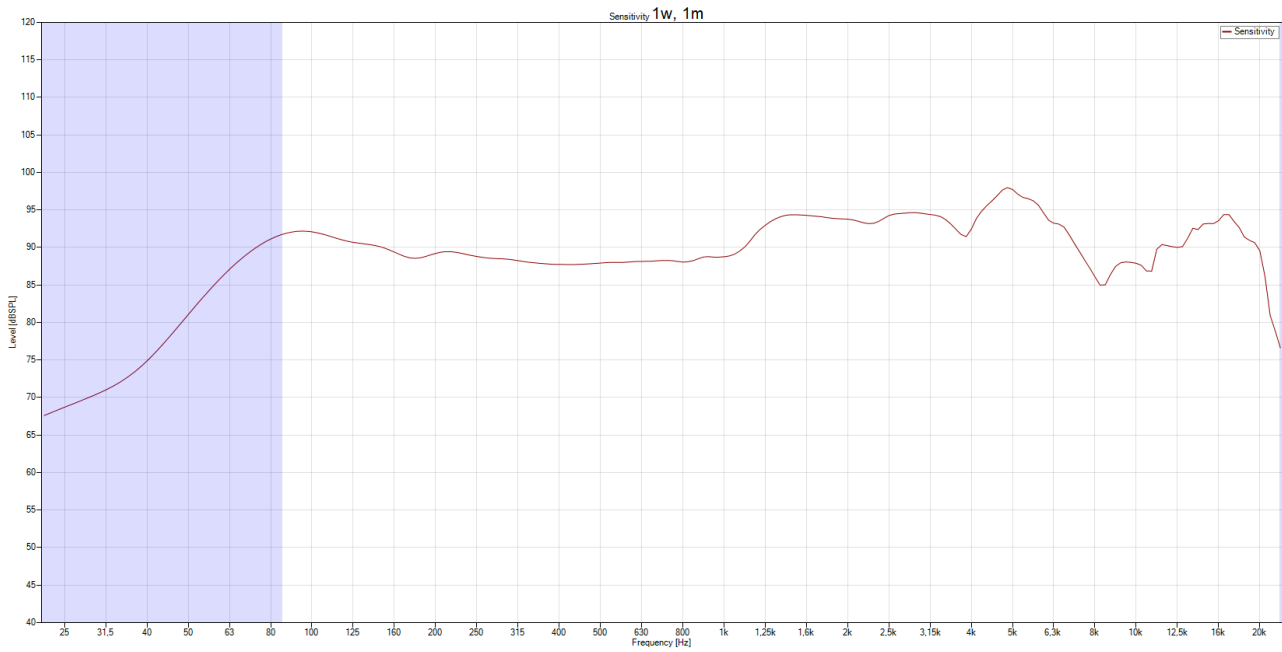

Polar Diagrams

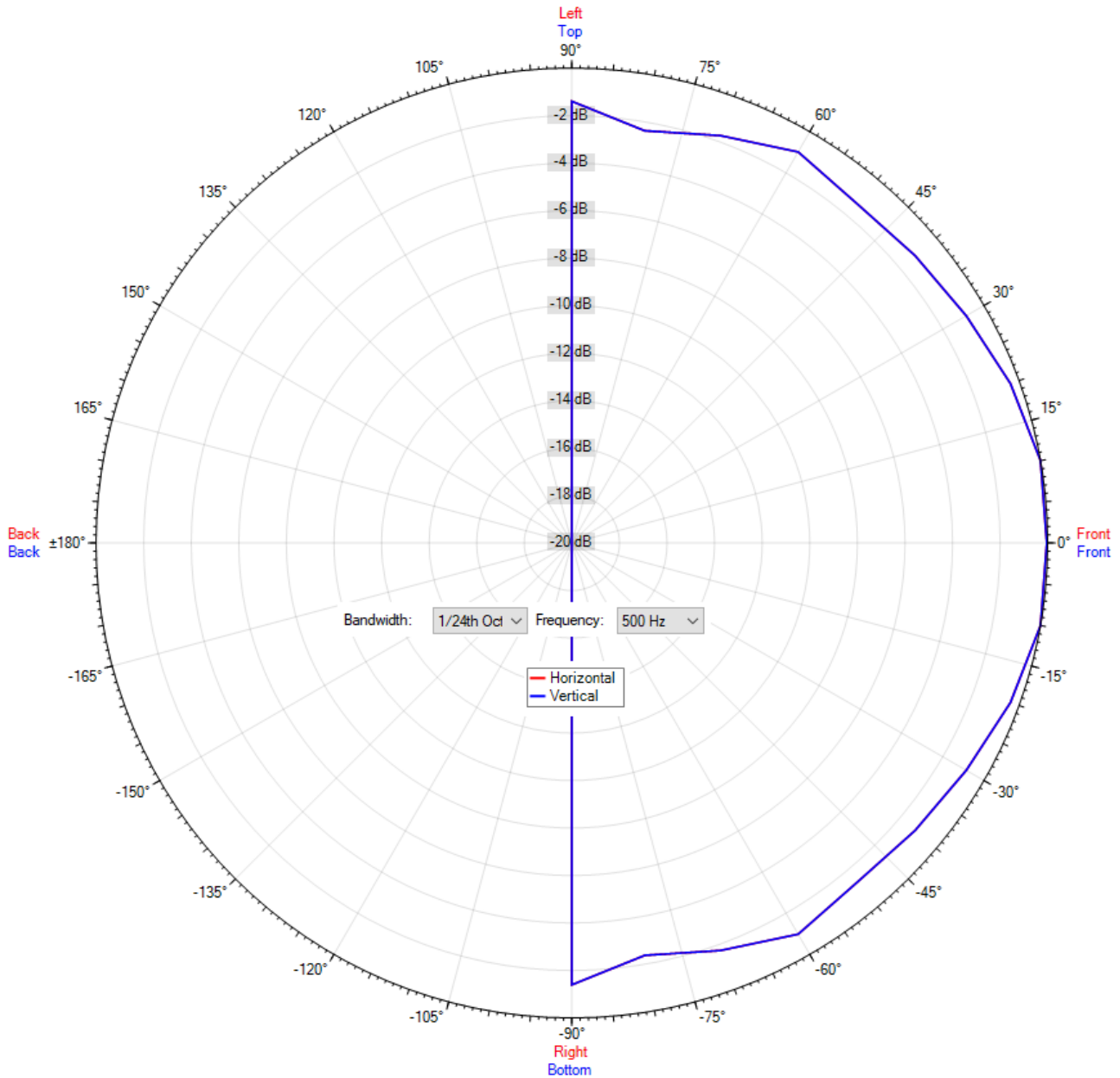

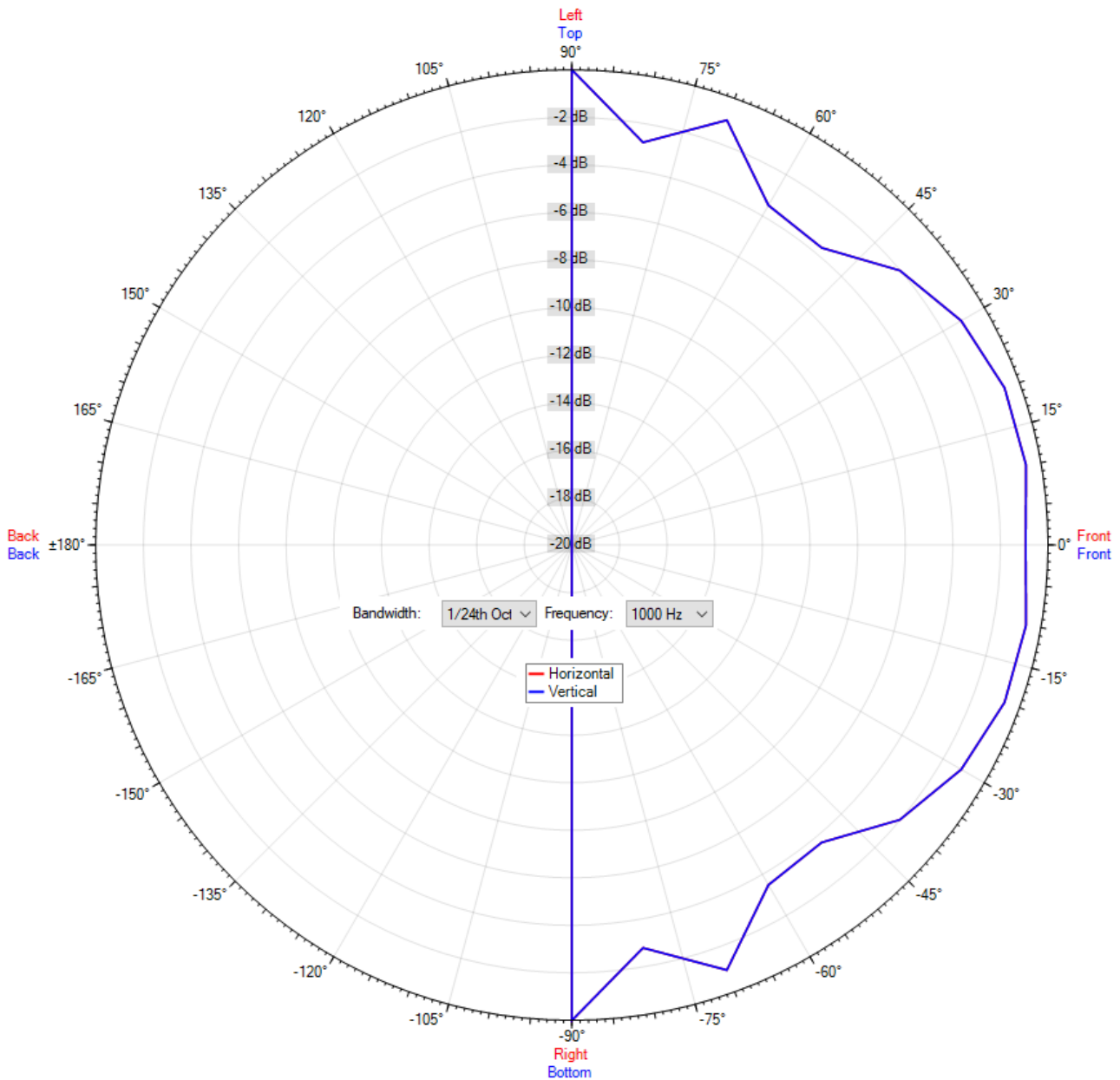

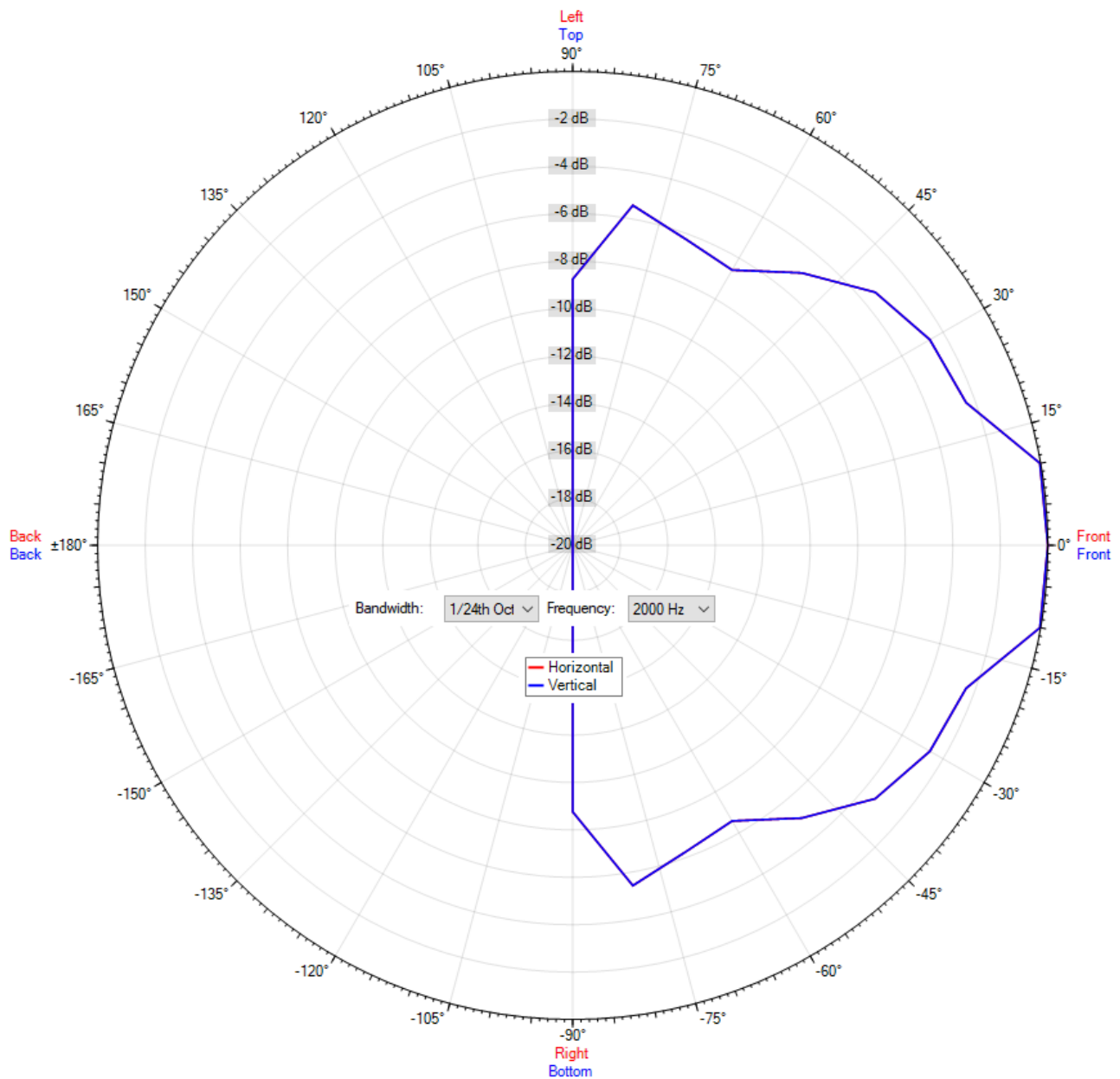

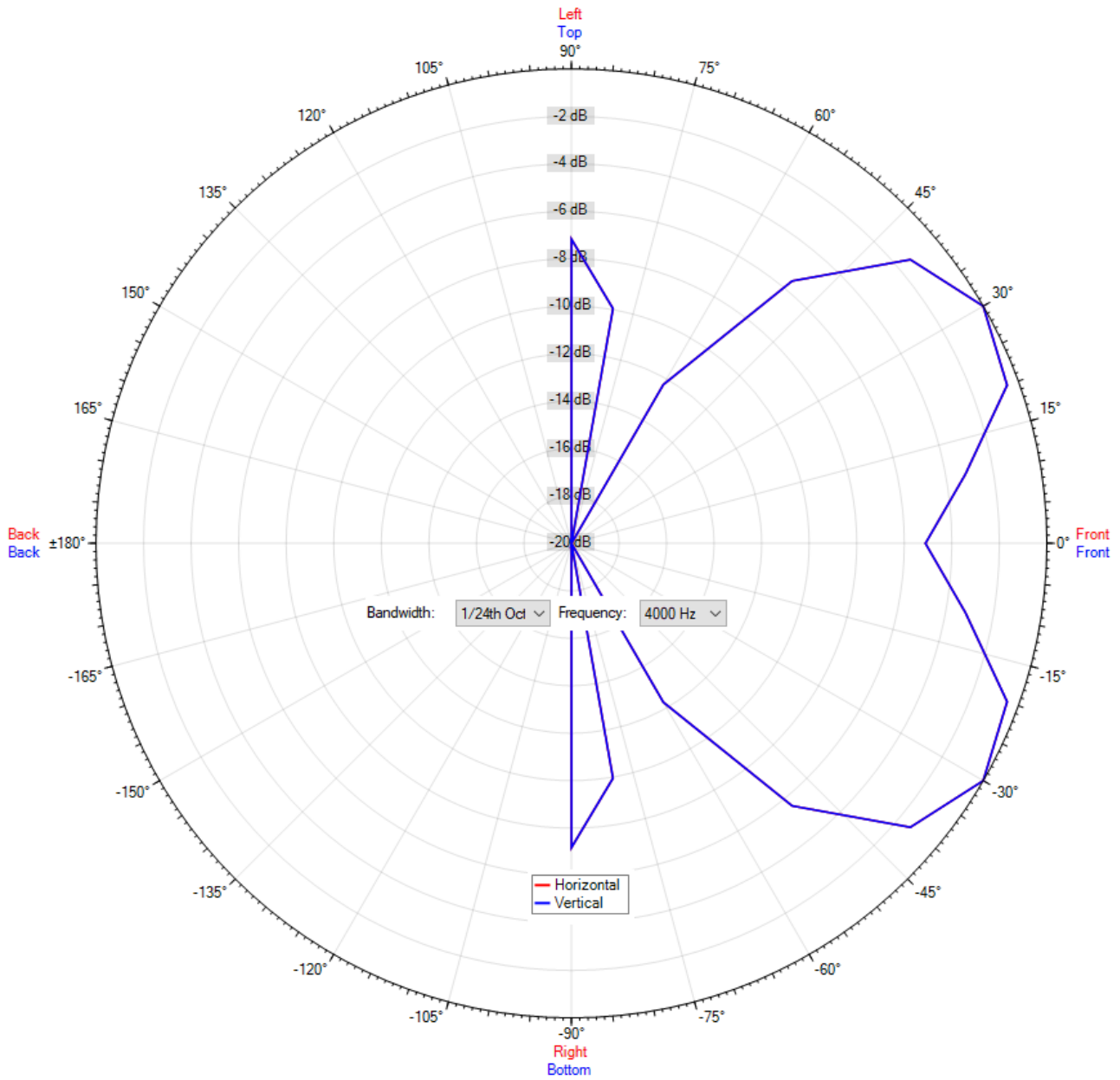

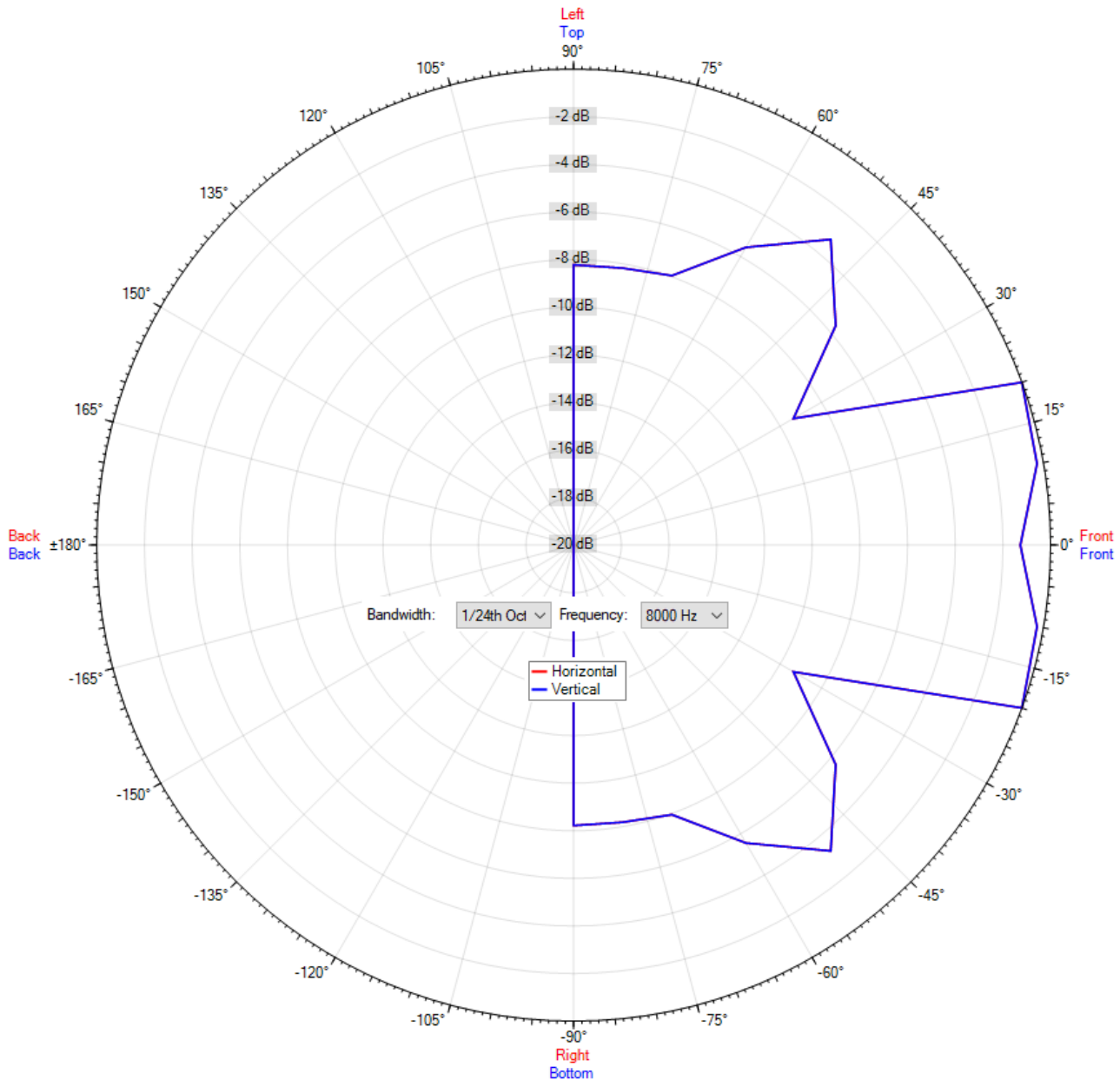

ic audio loudspeakers are tested and classified according to the IEC standard 60529 (degree of protection by enclosure) against the penetration of foreign objects and moisture. The classification is conforming to standards through characterization with a fixed code. This code consists of the letters IP (International Protection) followed by two digits. The first digit indicates the degree of protection against dust and the second digit the degree of protection against water. Please note that the testing of the products has been carried out in laboratory conditions which are not always 100% comparable with the conditions of different installation environments. This protection can be reduced due to normal wear and tear depending on the installation environment.

RoHS compliant (2011/65/EU)

The IP rating specified is based on ic audio test results, not on CNBOP-PIB test results. Certification only verifies the minimum requirements for EN54-24 compliance.

Article Nr.: 20194372

Packing Unit: 12

