



DK 15/T-EN54-PG

- High sound pressure level
- Weather-proof
- BS 5839



EN 54-24:2008
Ref. Nr.: 003-13
ID-Code: SAA-LS03
 1438-CPR-0242

ic audio GmbH, Boehringerstraße 14a,
 D-68307 Mannheim, Germany

CE-Symbol gemäß Richtlinie 93/68EWG

Technical Data (Electrical)

Description	DK 15/T-EN54-PG
Power	15/7,5/3,75/1,9 (20) W
Impedance (100V)	667/1333/2667/5263 ohm
Frequency Range	677 - 5.400 Hz
Frequency Response	300 - 13.800 Hz
SPL IEC268-5, 1W/1m	95,0 dB
SPL EN54-24, Pmax/4m	93,0 dB
Sensitivity EN54-24, 1W/4m	83,0 dB
Sensitivity EN54-24, 1W/1m	95,3 dB
Dispersion -6dB, 500Hz	h/v 360°
Dispersion -6dB, 1KHz	h/v 110°
Dispersion -6dB, 2KHz	h/v 70°

Dispersion -6dB, 4KHz h/v 40°

Technical Data (Mechanical)

Dimensions	209x321 mm
IP Rating	IP66
Weight (net)	2,08 kg
Temperature range	-25 / +70 C°
Mounting	Mounting bracket
Connector	ceramic block
Terminal diameter	3,2 mm
Maximum cable passage	8mm ²
Colour	RAL 7035

Product Attributes



Technical Diagrams

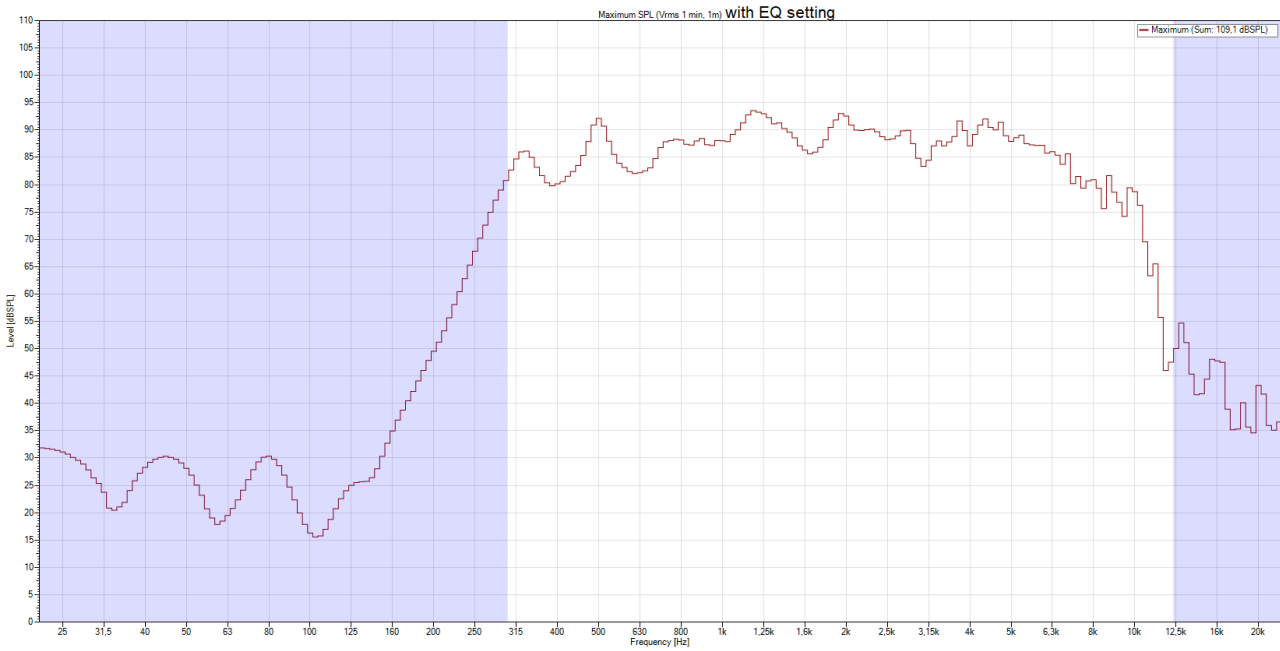
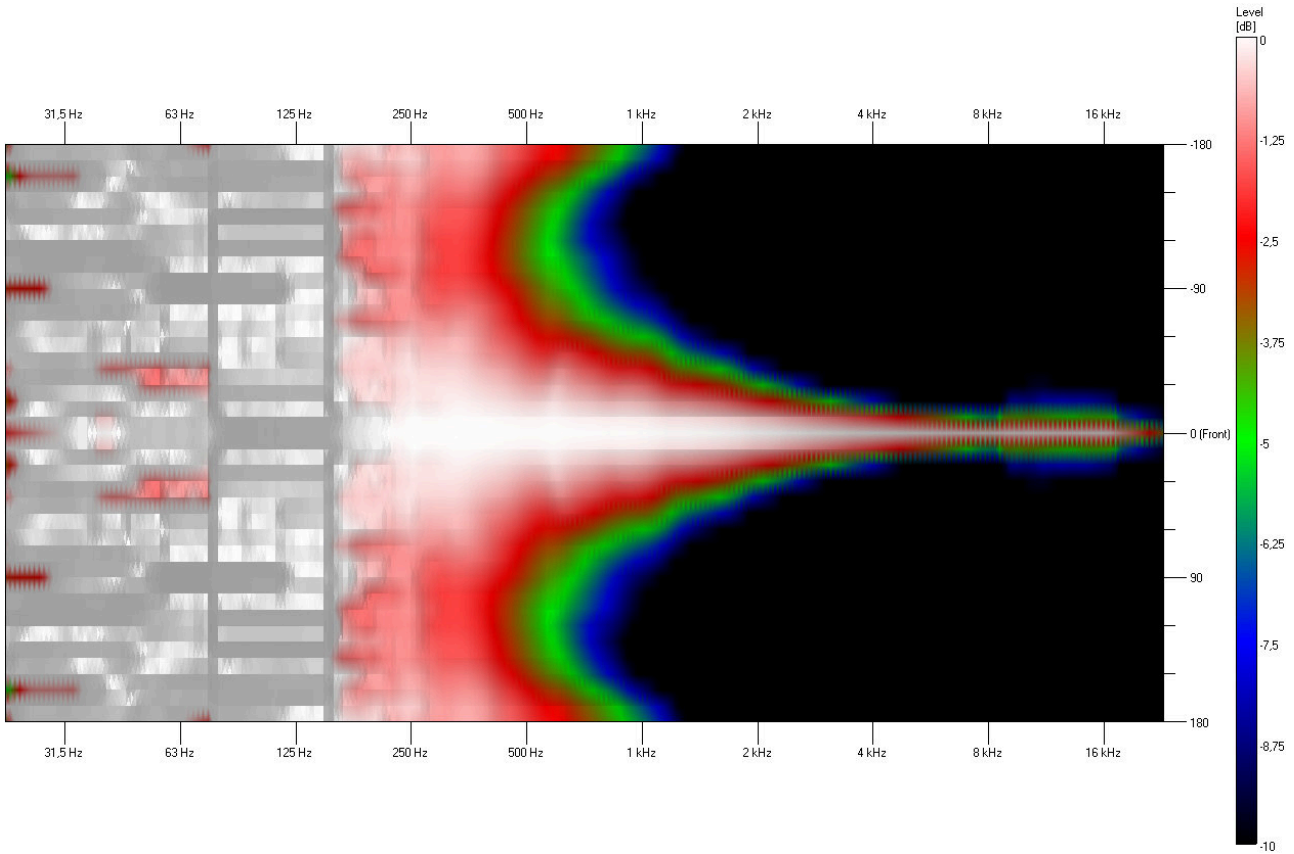

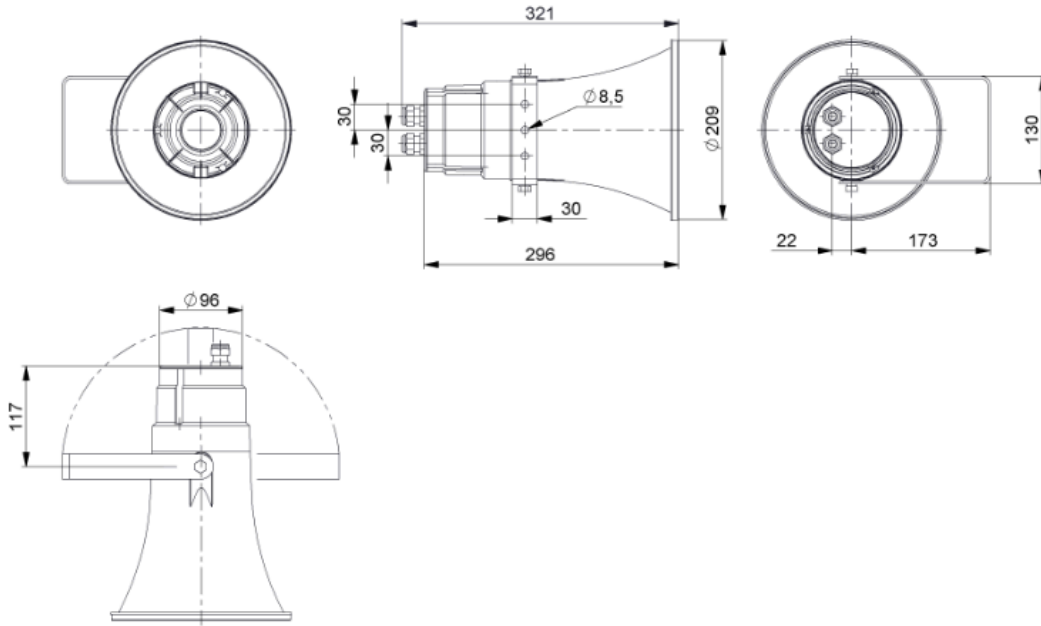

all dimensions are in mm

Frequency Response Diagrams

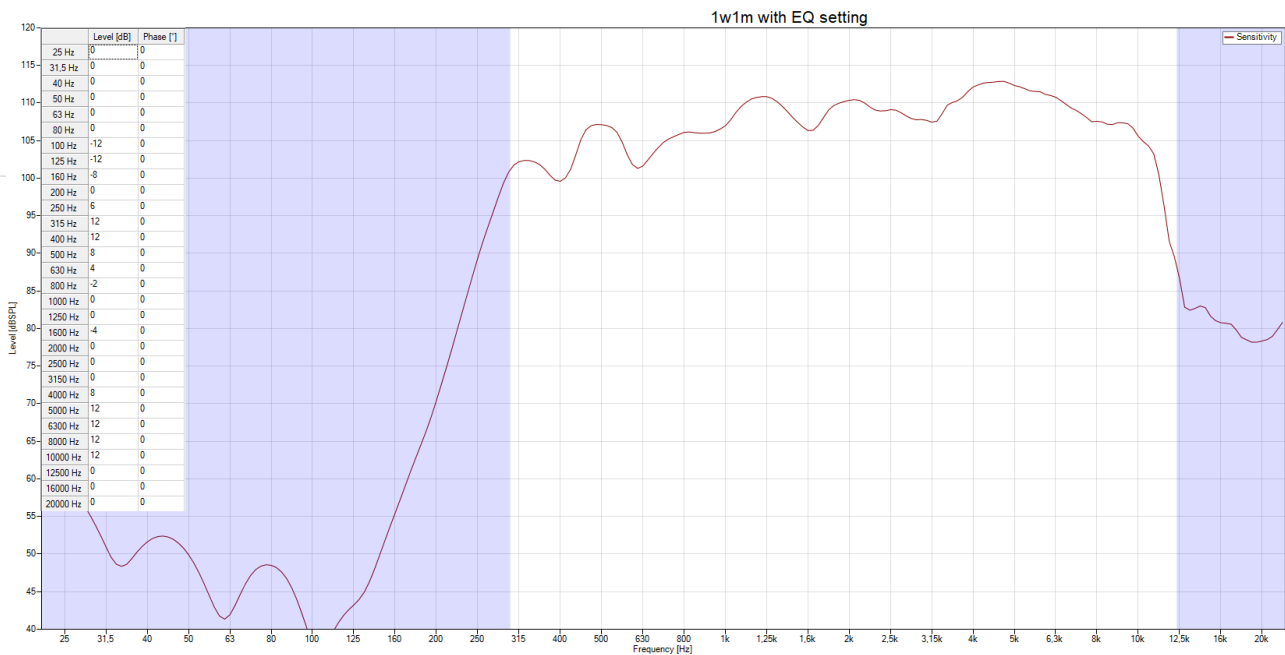

Polar Diagrams

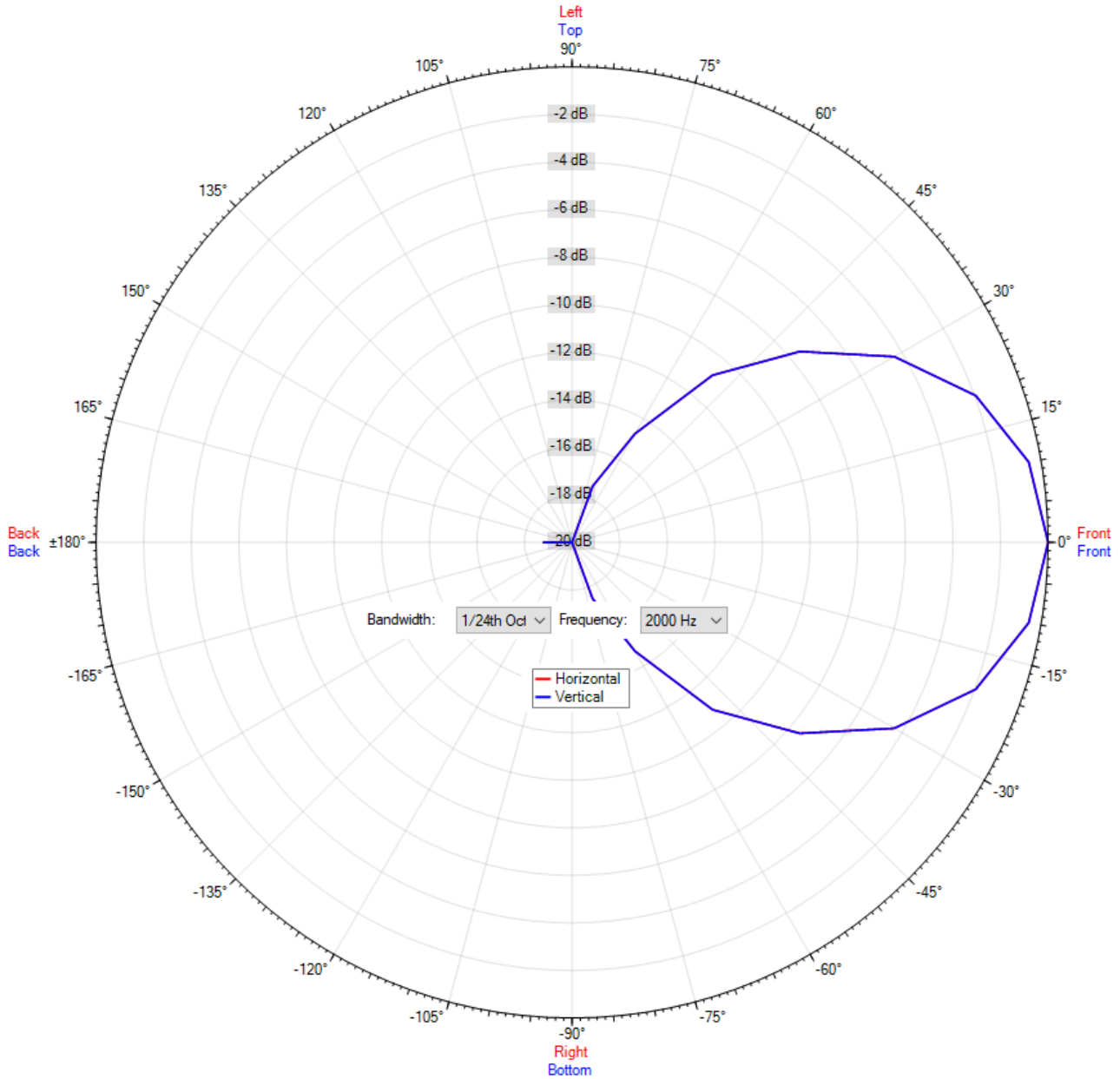

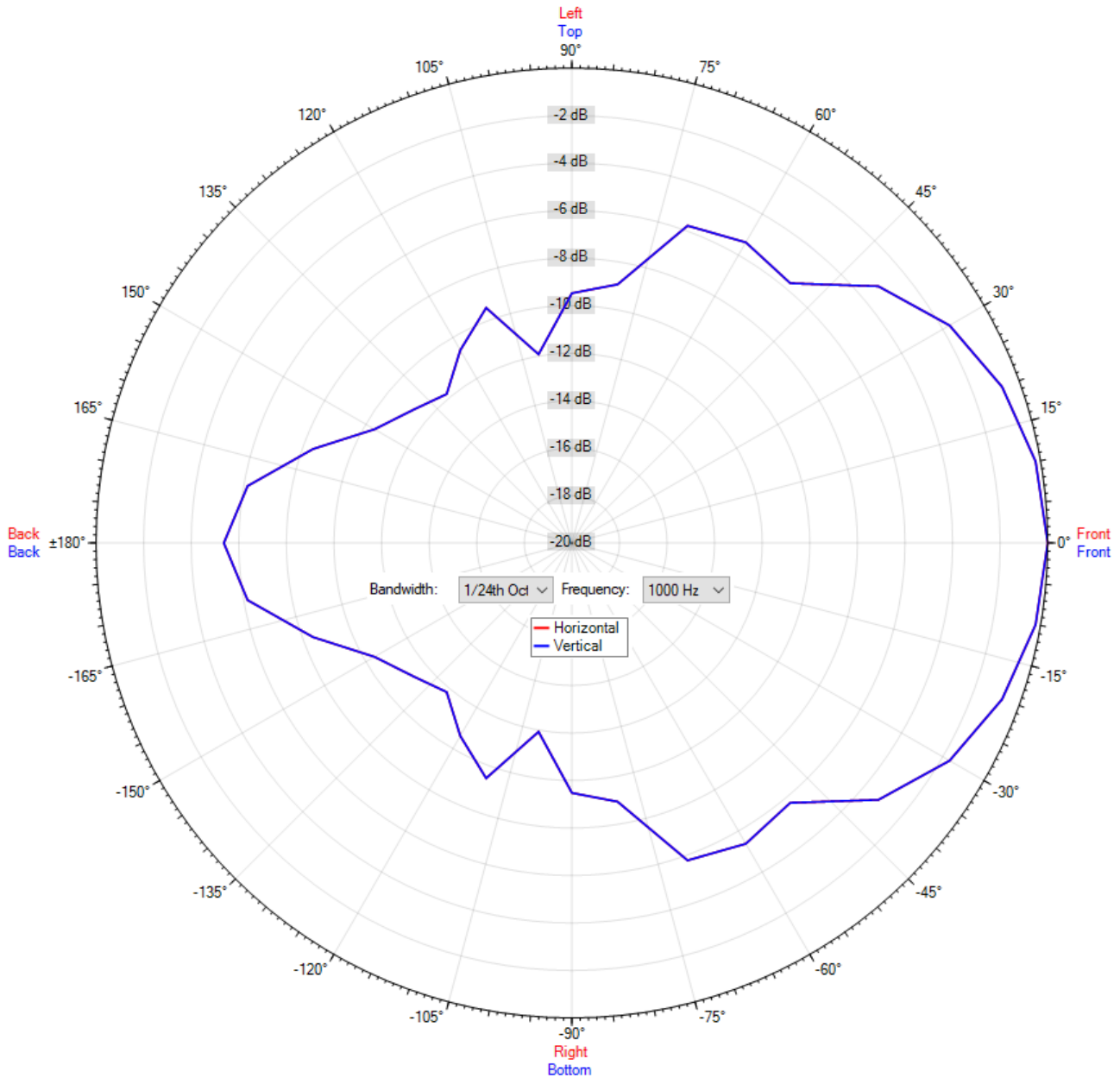

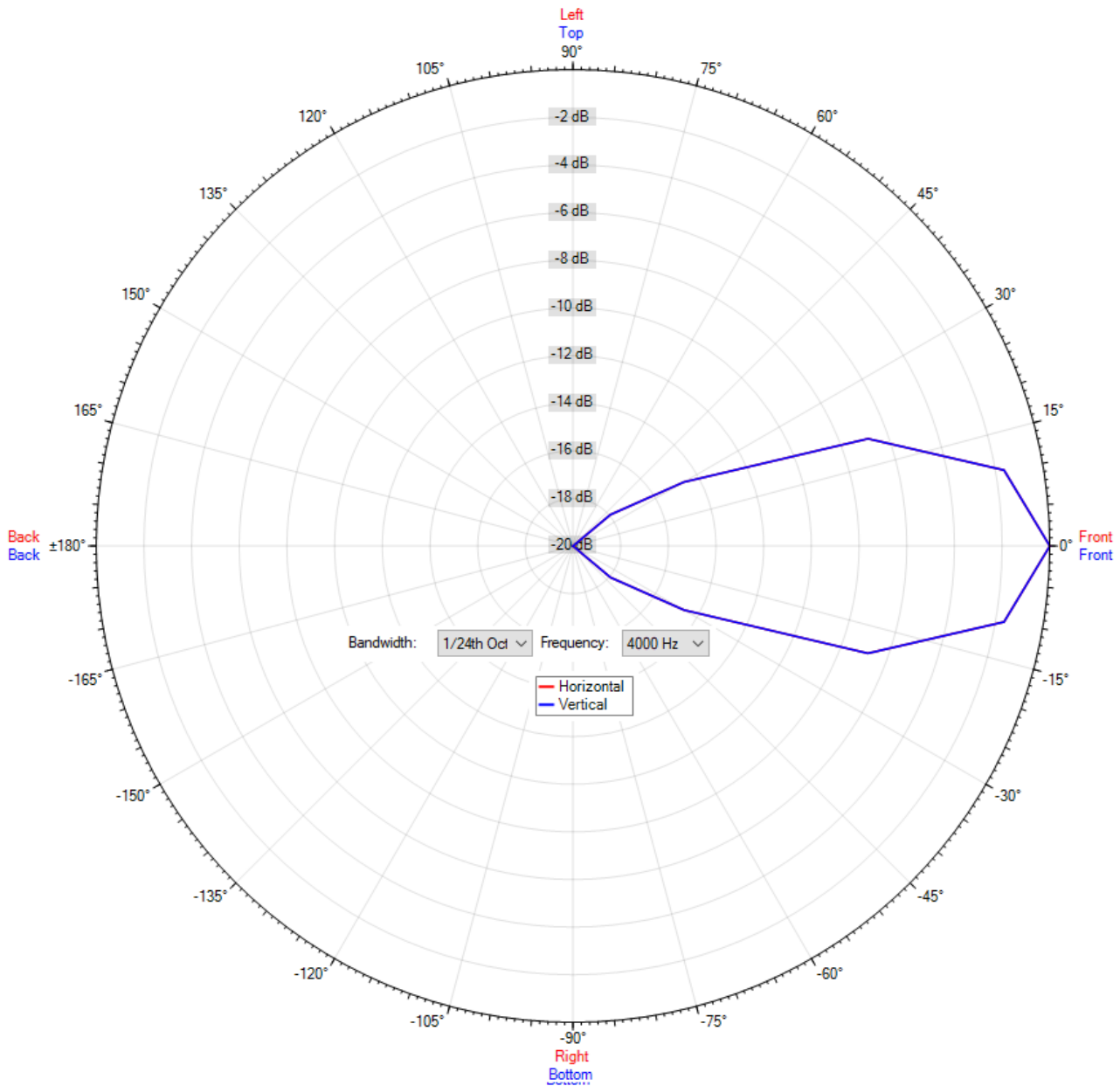

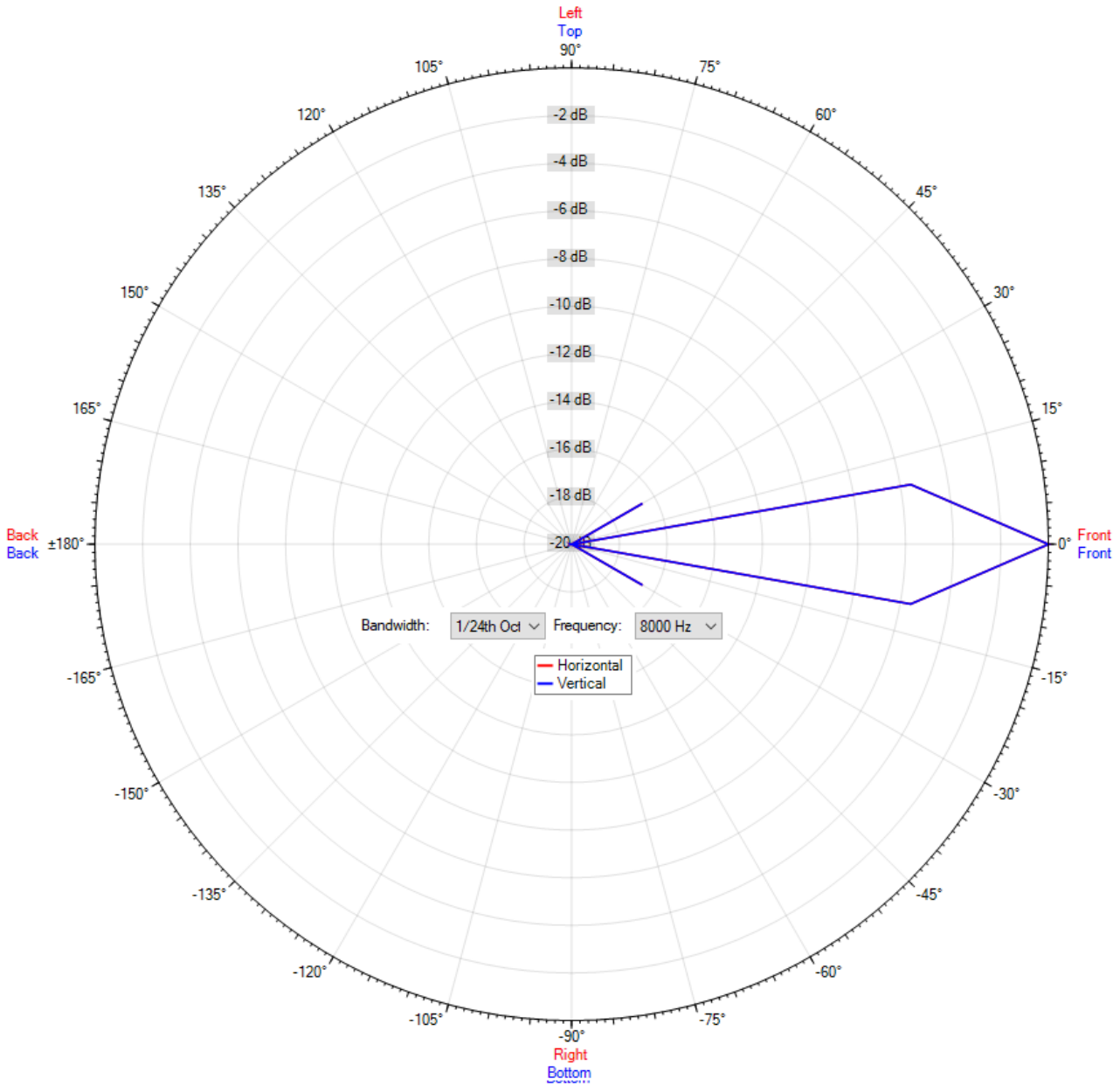

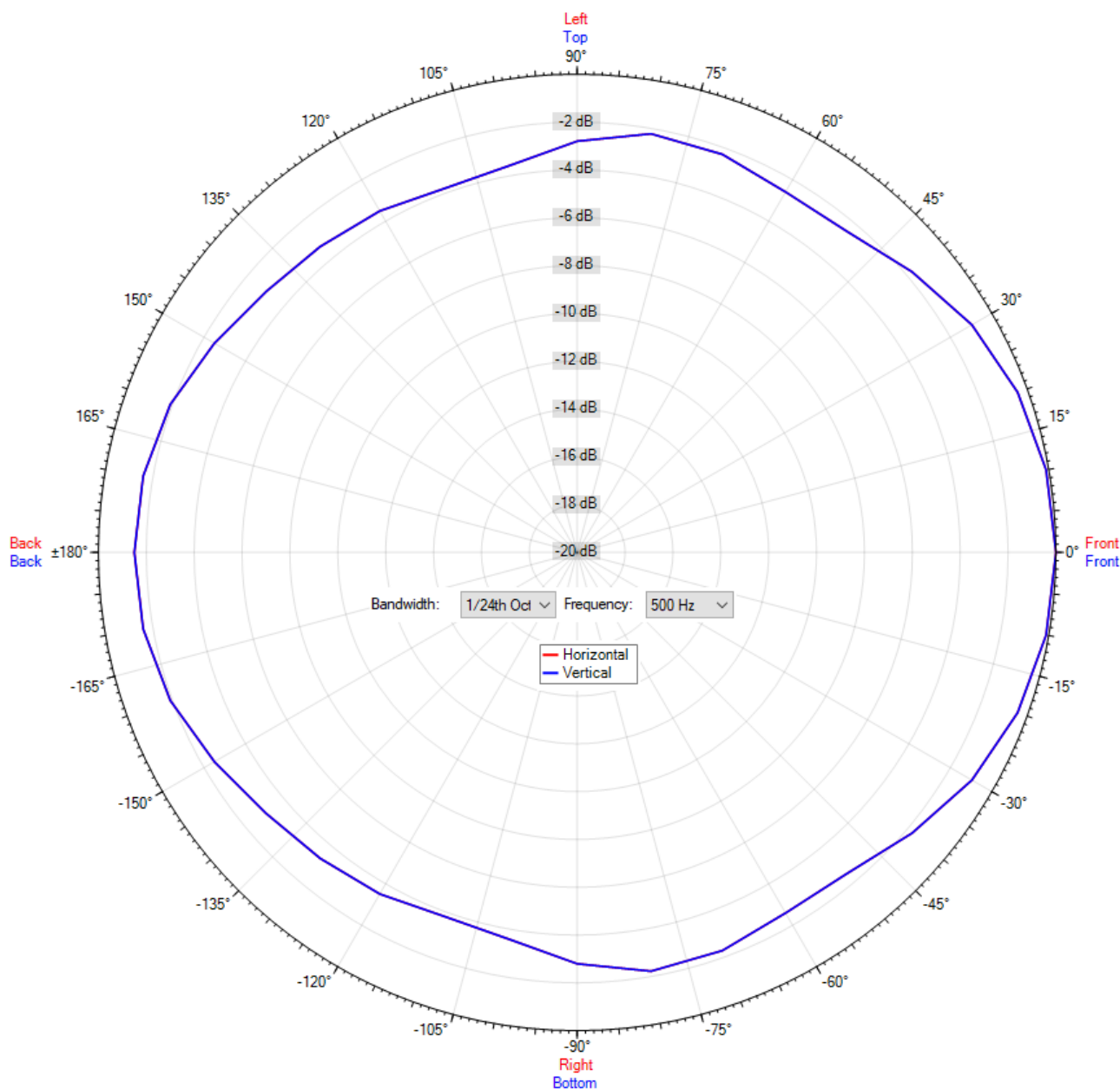

ic audio loudspeakers are tested and classified according to the IEC standard 60529 (degree of protection by enclosure) against the penetration of foreign objects and moisture. The classification is conforming to standards through characterization with a fixed code. This code consists of the letters IP (International Protection) followed by two digits. The first digit indicates the degree of protection against dust and the second digit the degree of protection against water. Please note that the testing of the products has been carried out in laboratory conditions which are not always 100% comparable with the conditions of different installation environments. This protection can be reduced due to normal wear and tear depending on the installation environment.

RoHS compliant (2011/65/EU)

The IP rating specified is based on ic audio test results, not on CNBOP-PIB test results. Certification only verifies the minimum requirements for EN54-24 compliance.

Article Nr.: 20205824-PG

Packing Unit: 8

